



Features and Design

This Multimedia Projector is designed with the most advanced technology for portability, durability, and ease of use. This projector utilizes built-in multimedia features, a palette of 16.77 million colors, and matrix liquid crystal display (LCD) technology.

Compact Design

This projector is designed compact in size and weight. It is easy to carry and installed anywhere you wish to use.

Simple Computer System Setting

The projector has the Multi-scan system to conform to almost all computer output signals quickly . Up to WXGA resolution can be accepted.

Useful Functions for Presentations

- The digital zoom function allows you to focus on the crucial information during a presentation .
- 7W audio output allows you to make a presentation without any external audio equipment.

Lamp Control

Brightness of the projection lamp can be selected.

Logo Function

The Logo function allows you to customize the screen logo . You can capture an image for the screen logo and use it for the starting-up display or between presentations.

Multilanguage Menu Display

Operation menu is available in 20 languages; English, Persian, Russian, Finnish, Dutch, Italian, Portuguese, French, German, Thai, Vietnamese, Japanese, Korean, Spanish, Indonesian, Turkish, Arabic, Afrikaans, Traditional Chinese, Simplified Chinese.

Helpful Maintenance Functions

Lamp and filter maintenance functions provide for better and proper maintenance of the projector.

✓ *Note:*

- *The screen menu and pictures in the manual may slightly differ from the real product.*
- *The manual is subject to change without prior notice.*

Security Function

The Security function helps you to ensure security of the projector. With the Key lock function, you can lock the operation on the top control or remote control. PIN code lock function prevents unauthorized use of the projector.

LAN Network Function

This projector is loaded with the Wired LAN network function. You can operate and manage the projector via network. For details, refer to the pages 50-53.

Auto Setup Function

This function enables Input search, Auto Keystone correction and Auto PC adjustment by simple pressing the AUTO button on the remote control.

Colorboard Function

At the time of simple projection on the colored wall, you can get the close color image to the color image projected on a white screen by selecting the similar color to the wall color from the preset four colors.

Switchable Interface Terminal

The projector provides a switchable interface terminal. You can use the terminal as computer input or monitor output conveniently.

Power Management

The Power management function reduces power consumption and maintains the lamp life.

Closed Caption

This is a printed version of the program sound or other information displayed on the screen. You can turn on the feature and switch the channels.

Contents

| | | | |
|---|----|---|----|
| Features and Design | 2 | System | 34 |
| Contents | 3 | Color adjust | 36 |
| Safety Instructions | 4 | Image Mode | 36 |
| Safety Guide | 5 | Color adjust(Computer) | 37 |
| Air circulation | 6 | Color adjust | 38 |
| Moving the projector | 6 | (Vdioe,S-video,Component) | 38 |
| Installing the projector properly | 6 | Setting | 39 |
| Compliance | 7 | On start | 39 |
| Accessories | 8 | Standby mode | 39 |
| Part names and functions | 9 | High land | 40 |
| Front | 9 | Lamp control | 40 |
| Back | 9 | Cooling fast | 40 |
| Bottom | 9 | Closed Caption | 41 |
| Terminals | 10 | Key lock | 41 |
| Top Control and Indicators | 11 | Iris | 42 |
| Remote control | 12 | Terminal | 42 |
| Install remote control batteries | 14 | Sound | 42 |
| Operating range | 14 | Expand | 43 |
| Adjustable foot | 14 | Language | 43 |
| Installation | 15 | Auto setup | 43 |
| Positioning the projector | 15 | Logo | 44 |
| Connecting to computer(Digital and analog RGB) | 16 | Security | 45 |
| Connecting to video equipment (Video, S-Video) | 17 | Power management | 46 |
| Connecting to audio equipment | 18 | Filter counter | 46 |
| Connecting the AC power cord | 19 | Test Pattern | 47 |
| Basic operation | 20 | Network | 47 |
| Turn on the projector | 20 | Information | 49 |
| Turn off the projector | 21 | Network Control | 50 |
| How to operate the screen menu | 22 | Maintenance and cleaning | 54 |
| Menu bar | 23 | POWER indicator | 54 |
| Adjust zoom and focus | 24 | Cleaning the filter | 55 |
| Auto setup function | 24 | Filter counter reset | 55 |
| Volume | 25 | Clean the project lens | 56 |
| Remote control operation | 26 | Clean the cabinet | 56 |
| Input select | 28 | Replace the lamp | 57 |
| PC Adjust | 29 | Appendix | 59 |
| Auto PC adj. | 29 | Troubleshooting | 59 |
| Manual PC adj. | 30 | Indicator and projector state | 61 |
| Display | 31 | Compatible computer specifications | 62 |
| Screen Size | 31 | Configurations of terminals | 63 |
| Keystone | 32 | Content of hazardous substances and elements | 63 |
| Project Mode | 32 | Dimensions | 64 |
| Menu Position | 33 | PIN code memorandum | 65 |
| Background Display | 33 | | |

Trademarks

Each name of corporations or products in this book is either a registered trademark or a trademark of its respective corporation.





Safety Instructions

Please read this manual completely before installing and operating the projector.

The projector provides many convenient features and functions. Proper operation may enable you to fully utilize the features and keep it in good condition. Otherwise, it will not only shorten the service life of the unit, but also may cause malfunction, a fire, or other accidents.

If your projector cannot work properly, please read this manual again, check the operating methods and cable connection, and try the solutions in the part of Troubleshooting. If the problem still exists, contact the dealer or the service center.

The lamp of the projector is a wearing part. The luminance may decrease after a period of operation and be weaker than that of a new lamp. This is normal. Please strictly follow the steps in Turning on the unit and Turning off the unit to turn on/off the projector, and the requirements in Maintaining and cleaning the projector to service and clean the projector regularly. Or the high temperature residual heat may not radiate, greatly shortening the service life of the projector and lamp, or even damaging them within a short period.

| |
|--|
|  <div style="background-color: black; color: white; padding: 5px; text-align: center; font-weight: bold;"> Caution ELECTRIC SHOCK DO NOT OPEN </div>  |
| <p>CAUTION: TO REDUCE THE RISK OF ELECTRIC SHOCK, DO NOT REMOVE COVER (OR BACK), NO USER SERVICEABLE PARTS INSIDE EXCEPT LAMP REPLACEMENT. REFER SERVICING TO QUALIFIED SERVICE PERSONNEL.</p> |
| <p> THIS SYMBOL INDICATES THAT DANGEROUS VOLTAGE CONSTITUTING A RISK OF ELECTRIC SHOCK IS PRESENT WITHIN THIS UNIT.</p> |
| <p> THIS SYMBOL INDICATES THAT THERE ARE IMPORTANT OPERATING AND MAINTENANCE INSTRUCTIONS IN THE USER'S MANUAL WITH THIS UNIT.</p> |

FOR EU USERS

The symbol mark and recycling systems described below apply to EU countries and do not apply to countries in other areas of the world.

Your product is designed and manufactured with high quality materials and components which can be recycled and/or reused.

The symbol mark means that electrical and electronic equipment, batteries and accumulators, at their end-of-life, should be disposed of separately from your household waste.

Note:

If a chemical symbol is printed beneath the symbol mark, this chemical symbol means that the battery or accumulator contains a heavy metal at a certain concentration. This will be indicated as follows: Hg: mercury, Cd: cadmium, Pb: lead. In the European Union there are separate collection systems for used electrical and electronic equipment, batteries and accumulators.

Please, dispose of them correctly at your local community waste collection/recycling centre.
 Please help us to conserve the environment we live in!



Safety precautions

- Caution:**
- The projector must be grounded.
 - Do not expose the projector to raindrops or high humidity to avoid a fire or electric shock.
 - This projector produces intense light from the projection lens. Avoid staring directly into the lens, otherwise eye damage could be caused. Be especially careful that children do not stare directly into the beam.
 - Place the projector in a proper position. Otherwise it may result in fire hazard.
 - Leave an appropriate space from the top, sides, and back of the shell in order to ventilate and cool down the projector. The figures below indicate the minimum distance to be left. It must be satisfied if the projector is placed in sealed environment like a cabinet.

SIDE and TOP

REAR

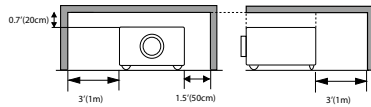

- Do not cover the vent of the projector. Poor radiation may shorten the service life or even cause dangers.
- Remove the AC power plug if the projector is not to be used for a long time.
- Do not project the same image for a long time; otherwise, a residual image may appear on the LCD panel due to its characteristic.



Caution

Do not set the projector in greasy, wet, or smoky conditions such as in a kitchen, to prevent a malfunction or accident. If the projector comes in contact with oil or chemicals, it may become deteriorated.

Read and keep this manual for future reference.

The mains plug/appliance coupler is used as disconnect device, the disconnect device shall remain readily operable.



Environment-friendly use conditions: The environment-friendly life time of the projector and remote control is 10 years, the lamp (consumable) 5 years, and the provided batteries (consumable) 5 years.

The use conditions of the environment-friendly use period are the same with that of the product. Properly operate and effectively maintain the projector according to the requirements in this manual.

Safety Guide

All the safety and operating instructions should be read before the product is operated.

Read all of the instructions given here and retain them for later use. Unplug this projector from AC power supply before cleaning. Do not use liquid or aerosol cleaners.

Use a damp cloth for cleaning.

Follow all warnings and instructions marked on the projector.

For added protection to the projector during a lightning storm, or when it is left unattended and unused for long periods of time, unplug it from the wall outlet. This will prevent damage due to lightning and power line surges.

Do not expose this unit to rain or use near water... for example, in a wet basement, near a swimming pool, etc...

Do not use attachments not recommended by the manufacturer as they may cause hazards.

Do not place this projector on an unstable cart, stand, or table. The projector may fall, causing serious injury to a child or adult, and serious damage to the projector.

Use only with a cart or stand recommended by the manufacturer, or sold with the projector. Wall or shelf mounting should follow the manufacturer's instructions, and should use a mounting kit approved by the manufacturers.

An appliance and cart combination should be moved with care. Quick stops, excessive force, and uneven surfaces may cause the appliance and cart combination to overturn.



Slots and openings in the back and bottom of the cabinet are provided for ventilation, to ensure reliable operation of the equipment and to protect it from overheating.

The openings should never be covered with cloth or other materials, and the bottom opening should not be blocked by placing the projector on a bed, sofa, rug, or other similar surface. This projector should never be placed near or over a radiator or heat register.

This projector should not be placed in a built-in installation such as a book case unless proper ventilation is provided.

Never push objects of any kind into this projector through cabinet slots as they may touch dangerous voltage points or short out parts that could result in a fire or electric shock. Never spill liquid of any kind on the projector.

Do not install the projector near the ventilation duct of air-conditioning equipment.

This projector should be operated only from the type of power source indicated on the marking label. If you are not sure of the type of power supplied, consult your authorized dealer or local power company.

Do not overload wall outlets and extension cords as this can result in fire or electric shock. Do not allow anything to rest on the power cord. Do not locate this projector where the cord may be damaged by persons walking on it.

Do not attempt to service this projector yourself as opening or removing Covers may expose you to dangerous voltage or other hazards. Refer all servicing to qualified service personnel.

Unplug this projector from wall outlet and refer servicing to qualified service personnel under the following conditions:

- When the power cord or plug is damaged or frayed.
- If liquid has been spilled into the projector.
- If the projector has been exposed to rain or water.
- If the projector does not operate normally by following the operating instructions. Adjust only those controls that are covered by the operating instructions as improper adjustment of other controls may result in damage and will often require extensive work by a qualified technician to restore the projector to normal operation.
- If the projector has been dropped or the cabinet has been damaged.
- If the projector exhibits a distinct change in performance-this indicates a need for service.

When replacement parts are required, be sure the service technician has used replacement parts specified by the manufacturer that have the same characteristics as the original part. Unauthorized substitutions may result in fire, electric shock, or injury to persons.

Upon completion of any service or repairs to this projector, ask the service technician to perform routine safety checks to determine that the projector is in safe operating condition.

Information for users in the European Union

This is a device to project images onto a screen, etc., and is not intended for use as indoor lighting in a domestic environment. Directive 2009/125/EC.

NOTE FOR CUSTOMERS IN THE US

 LAMP(S) INSIDE THIS PRODUCT CONTAIN MERCURY AND MUST BE RECYCLED OR DISPOSED OF ACCORDING TO LOCAL STATE OR FEDERAL LAWS.

Safety Guide

Air circulation

Vents in the cabinet are provided for ventilation. To ensure reliable operation of the product and to protect it from overheating, these openings must not be blocked or covered.



Caution

Hot air is exhausted from the exhaust vent. When using or installing the projector, the following precautions should be taken.

- Do not put any flammable objects, or spray can near the projector. Hot air is exhausted from the air vents.
- Keep the exhaust vent at least 1 m away from any objects.
- Do not touch a peripheral part of the exhaust vent, especially screws and metallic part. This area will become hot while the projector is being used.
- Do not put anything on the projector. Objects put on the cabinet will not only get damaged but also may cause fire hazard by heat. Cooling fans are provided to cool down the projector. The fan's running speed is changed according to the temperature inside the projector.

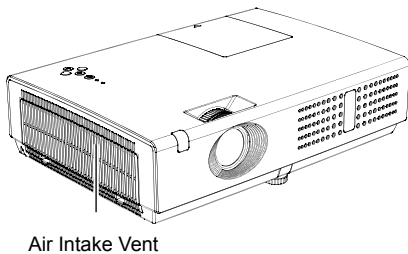
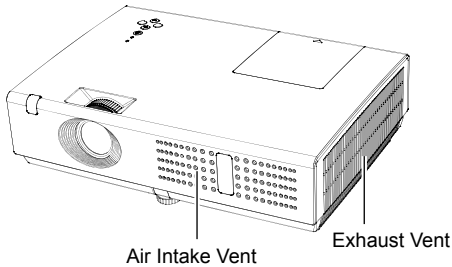

Moving the projector

When moving the projector, take care of the lens and retract the adjustable foot to prevent damage to the lens and cabinet.

Installing the projector properly

Please set the projector on nearly-level.

Be sure to install the projector properly. Improper installation may reduce the lamp lifetime and even cause a fire hazard.

Do not roll the projector over 20 degrees from side to side.

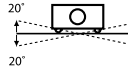

Do not point the projector up to project an image.



Do not point the projector down to project an image.



Do not put the projector on either side to project an image.



Caution in ceiling installation the projector

- Only qualified personal is authorized for ceiling installation.
- We are not responsible for the hurt and damage caused by ceiling bracket that purchased from unauthorized dealer even in warranty period.
- Remove the ceiling bracket immediately while not use.
- While installing, torque screwdriver is suggested, don't use electric or impact-type screwdriver.
- Please read the manual of bracket for details.
- The bracket is subject to change without notice.

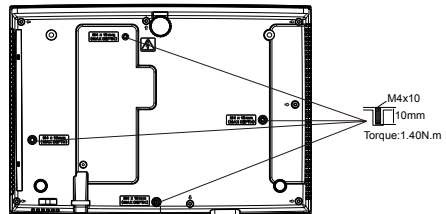

Caution in moving or transporting the projector

- Do not drop or bump the projector, otherwise damages or malfunctions may result.
- When carrying the projector, use a suitable carrying case.
- Do not transport the projector by courier or any other transport service in an unsuitable transport case. This may cause damage to the projector. For information about transporting the projector by courier or any other transport service, consult your dealer.
- Do not put the projector in a case before it is cooled enough.

Compliance

FCC Caution

Note: This equipment has been tested and found to comply with the limits for a Class B digital device, pursuant to Part 15 of the FCC Rules. These limits are designed to provide reasonable protection against harmful interference in a residential installation. This equipment generates, uses, and can radiate radio frequency energy, and if not installed and used in accordance with the instructions, may cause harmful interference to radio communications. However, there is no guarantee that interference will not occur in a particular installation. If this equipment does cause harmful interference to radio or television reception, which can be determined by turning the equipment off and on, the user is encouraged to try to correct the interference by one or more of the following measures:

- Reorient or relocate the receiving antenna.
- Increase the separation between the equipment and receiver.
- Connect the equipment into an outlet on a circuit different from that to which the receiver is connected.
- Consult the dealer or an experienced radio/TV technician for help.

Use of shielded cable is required to comply with class B limits in Subpart B of Part 15 of FCC Rules. Do not make any changes or modifications to the equipment unless otherwise specified in the instructions. If such changes or modifications should be made, you could be required to stop operation of the equipment.

AC Power Cord Requirement

The AC Power Cord supplied with this projector meets the requirement for use in the country you purchased it.

AC Power Cord for the United States and Canada:

AC Power Cord used in the United States and Canada is listed by the Underwriters Laboratories (UL) and certified by the Canadian Standard Association (CSA).

AC Power Cord has a grounding-type AC line plug. This is a safety feature to be sure that the plug will fit into the power outlet. Do not try to defeat this safety feature. Should you be unable to insert the plug into the outlet, contact your electrician.

AC Power Cord for the United Kingdom:

This cord is already fitted with a moulded plug incorporating a fuse, the value of which is indicated on the pin face of the plug. Should the fuse need to be replaced, an ASTA approved BS 1362 fuse must be used of the same rating, marked thus . If the fuse cover is detachable, never use the plug with the cover omitted. If a replacement fuse cover is required, ensure it is of the same colour as that visible on the pin face of the plug (i.e. red or orange). Fuse covers are available from the Parts Department indicated in your User Instructions.

If the plug supplied is not suitable for your socket outlet, it should be cut off and destroyed.

The end of the flexible cord should be suitably prepared and the correct plug fitted.

WARNING : A PLUG WITH BARED FLEXIBLE CORD IS HAZARDOUS IF ENGAGED IN A LIVE SOCKET OUTLET.

The Wires in this mains lead are coloured in accordance with the following code:

| | |
|----------------------------|---------|
| Green-and-yellow | Earth |
| Blue | Neutral |
| Brown | Live |

As the colours of the wires in the mains lead of this apparatus may not correspond with the coloured markings identifying the terminals in your plug proceed as follows:

The wire which is coloured green-and-yellow must be connected to the terminal in the plug which is marked by the letter E or by the safety earth symbol  or coloured green or green-and-yellow.

The wire which is coloured blue must be connected to the terminal which is marked with the letter N or coloured black.

The wire which is coloured brown must be connected to the terminal which is marked with the letter L or coloured red.

WARNING: THIS APPARATUS MUST BE EARTHED.

THE SOCKET-OUTLET SHOULD BE INSTALLED NEAR THE EQUIPMENT AND EASILY ACCESSIBLE.

Accessories

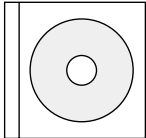
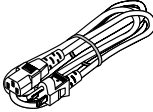
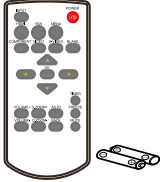
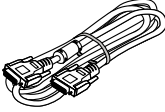
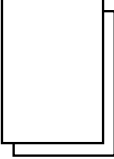
| User's Manual(CD) | AC Power cord | Remote control with batteries (AAA or LR03) |
|---|---|---|
|  |  |  |
| VGA cable | Quick start guide | |
|  |  | |

Part names and functions

Front

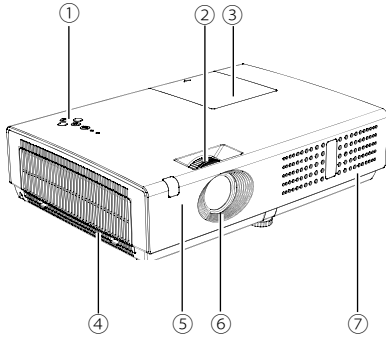

- ① Top control and Indicators
- ② Zoom ring
- ③ Lamp cover
- ④ Filter
- ⑤ Remote control receiver
- ⑥ Projector lens
- ⑦ Air intake vent

Back

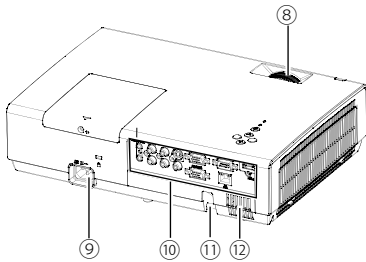

- ⑧ Focus ring
- ⑨ AC cord connector
- ⑩ Terminals
- ⑪ Anti-theft slot
- ⑫ Speaker

Bottom

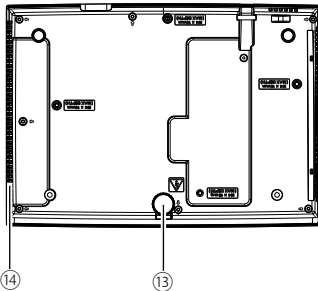

- ⑬ Adjustable foot
- ⑭ Exhaust vent



Caution

Hot air is exhausted from the exhaust vent. Do not put heat-sensitive objects near this side.

Part names and functions

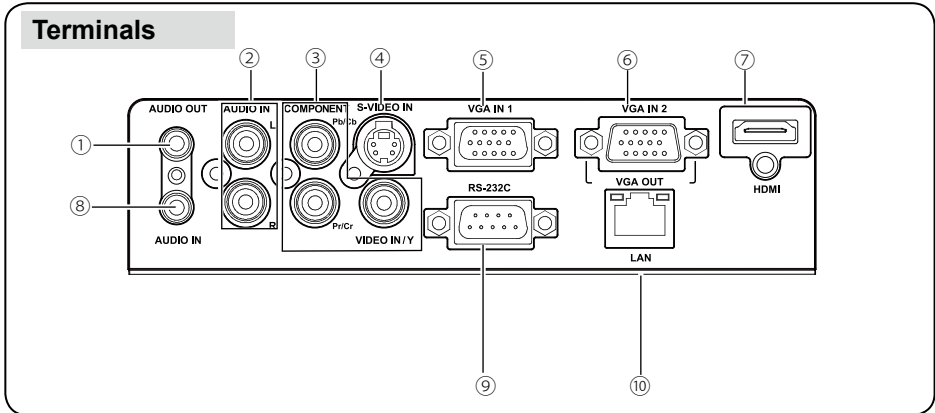

① AUDIO OUT *

- Connect external audio amplifier to this jack.
- Output audio signal from ②, ⑦ or ⑧.

② AUDIO IN (R/L) *

- Connect the video equipment connected to ③ or ④ to this jack.
- For a mono audio signal (a single audio jack), connect it to L(MONO) jack.

③ COMPONENT/VIDEO IN

- Connect video signal to VIDEO port.
- Connect composite video or component video signal to this jack.

④ S-VIDEO IN

Connect S-Video signal to this jack.

⑤ VGA IN 1

Connect a computer output to this terminal.

⑥ VGA IN 2/VGA OUT

- Connect a computer output to this terminal.
- Output the analog signal from ⑥ to other monitor.

⑦ HDMI *

Connect a HDMI output to this terminal.

⑧ AUDIO IN *

Connect the audio signal output from computer equipment connected to ⑤ or ⑥ to this jack.

⑨ RS-232C

When using RS232 to control the projector, please connect the serial control line to this terminal.

⑩ LAN *

Connect the wired LAN cable to this port.

**Some model doesn't support this function.*

Top Control and Indicators

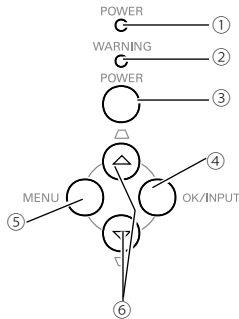

① POWER indicator

- Lights red when the projector is in stand-by mode.
- Lights green during operations.
- Flashes green in the Power management mode.
- Flashes red during fans cooling.
- Lights orange when abnormal is detected in the projector.
- Flashes orange when internal temperature is abnormally high.

② WARNING indicator

Lights red when the life of the projection lamp draws to an end.

③ POWER button

To turn on/off the projector.

④ OK/INPUT button

- Press INPUT button to select input source while no screen menu displayed.
- Enter screen menu or execute the selected item.

⑤ MENU button

Open or close the screen menu.

⑥ ▲▼/Keystone button

- Select items or adjust the data in screen menu.
- Correct image keystone distortion.

Part names and functions

Remote control

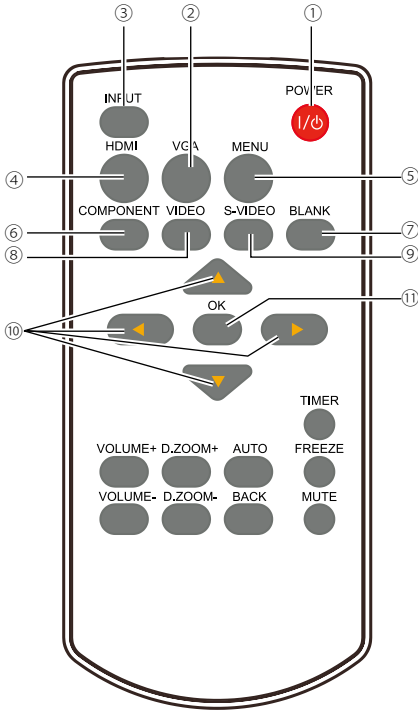

① **POWER**

Turn on or turn off the projector.(Page 21)

② **VGA**

Select VGA as input source.(Page 28)

③ **INPUT**

Enter input source menu to select input source directly. (Page 28)

④ **HDMI ***

Select HDMI as input source.(Page 28)

⑤ **MENU**

Open or close the screen menu.(Page 22)

⑥ **COMPONENT**

Select component as input source.(Page 28)

⑦ **BLANK**

Temporarily close the image on the screen. (Page 27)

⑧ **VIDEO**

Select Video as input source.(Page 28)

⑨ **S-VIDEO**

Select S-video as input source.(Page 28)

⑩ **▲▼◀▶**

- Select items or adjust the data in screen menu.
- Select the image display area in digital zoom mode.(Page 22)

⑪ **OK**

Enter screen menu or execute selected items.(Page 22)

**Some model doesn't support this function.*

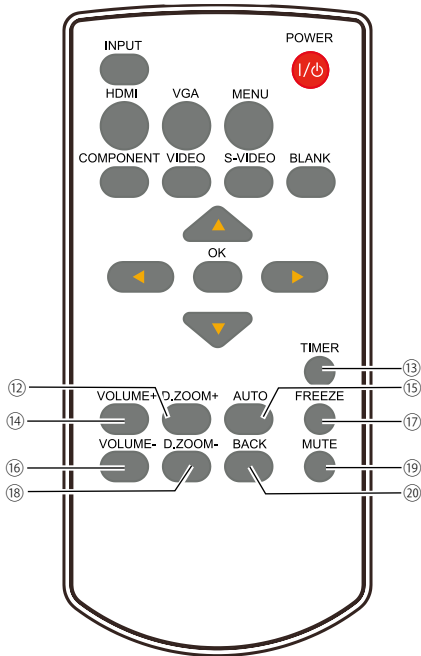

- ⑫ **DZOOM+**
Select the digital zoom + mode.(Page 27)
- ⑬ **TIMER**
Enable the timer function.(Page 27)
- ⑭ **VOUME +**
Increase the volume level.(Page 25)
- ⑮ **AUTO**
Enter auto setup mode.(Page 24)
- ⑯ **VOUME -**
Decrease the volume level.(Page 25)
- ⑰ **FREEZE**
Freeze the projected image.(Page 26)
- ⑱ **DZOOM-**
Select the digital zoom - mode.(Page 27)
- ⑲ **MUTE**
Mute the sound.(Page 25)
- ⑳ **BACK**
Return to main menu.(Page 22)

Part names and functions

Install remote control batteries

① Open the battery compartment lid.

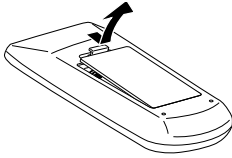

② Install new batteries into the compartment.

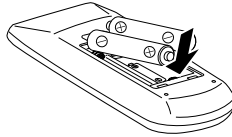

Two AAA batteries
For correct polarity (+ and -), be sure battery terminals are in contact with pins in the compartment.

③ Replace the compartment lid.

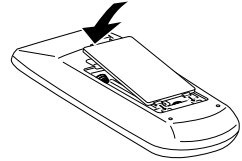

To ensure safe operation, please observe the following precautions:

- Use two (2) AAA or LR03 type alkaline batteries.
- Always replace batteries in sets.
- Do not use a new battery with a used battery.
- Avoid contact with water or liquid matter.
- Do not expose the remote control to moisture or heat.
- Do not drop the remote control.
- If the battery has leaked on the remote control, carefully wipe the case clean and install new batteries.
- Risk of explosion if a battery is replaced by an incorrect type.
- Dispose of used batteries according to the instructions on the battery or local regulations or guides.

Operating range

Point the remote control toward the projector remote receiver when pressing any button.

The maximum operating range for the remote control is about 5 meters and 60 degrees vertically and horizontally.

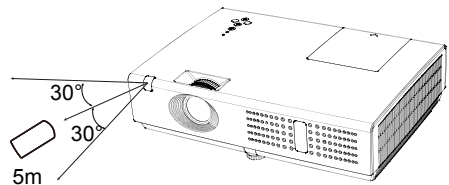

Adjustable foot

The projection angle can be adjusted up to 10.0 degrees with the adjustable foot.

Lift the front of the projector and press the lock on the adjustable foot to release it.

The foot is then locked. Rotate the foot to adjust the height and tilt angle.

Keystone distortion of projected images can be corrected by remote control or menu operation.

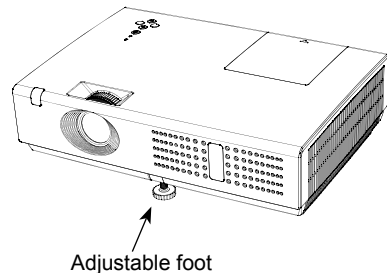

Installation

Positioning the projector

✓ Note:

- The brightness in a room has a great influence on picture quality. It is recommended to limit the ambient lighting in order to get the best image.
- All measurements are approximate and may vary from the actual sizes.

4:3

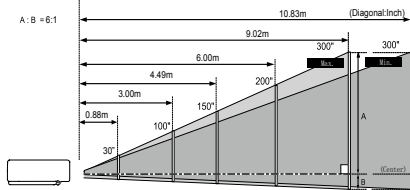

| Screen size (WxH)mm | 30" | 100" | 150" | 200" | 300" |
|---------------------|---------|-----------|-----------|-----------|-----------|
| 4:3 aspect ratio | 610x457 | 2032x1524 | 3048x2286 | 4064x3048 | 6096x4572 |
| Maximum | 0.88m | 3.00m | 4.49m | 6.00m | 9.02m |
| Minimum | 1.06m | 3.60m | 5.40m | 7.21m | 10.83m |

16:9

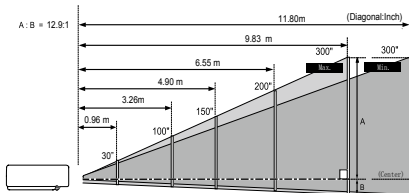

| Screen size (WxH)mm | 30" | 100" | 150" | 200" | 300" |
|---------------------|---------|-----------|-----------|-----------|-----------|
| 16:9 aspect ratio | 664x374 | 2214x1245 | 3321x1868 | 4428x2491 | 6641x3736 |
| Maximum | 0.96m | 3.26m | 4.90m | 6.55m | 9.83m |
| Minimum | 1.16m | 3.92m | 5.89m | 7.86m | 11.80m |

16:10

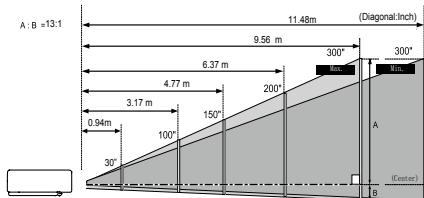

| Screen size (WxH)mm | 30" | 100" | 150" | 200" | 300" |
|---------------------|---------|-----------|-----------|-----------|-----------|
| 16:10 aspect ratio | 646x404 | 2154x1346 | 3231x2019 | 4308x2692 | 6462x4039 |
| Maximum | 0.94m | 3.17m | 4.77m | 6.37m | 9.56m |
| Minimum | 1.12m | 3.81m | 5.73m | 7.64m | 11.48m |

Installation

Connecting to computer(Digital and analog RGB)

Cables used for connection:

- VGA cable
- HDMI cable
(Cables are not supplied with the projector)
- Serial control cable
(Cables are not supplied with the projector)

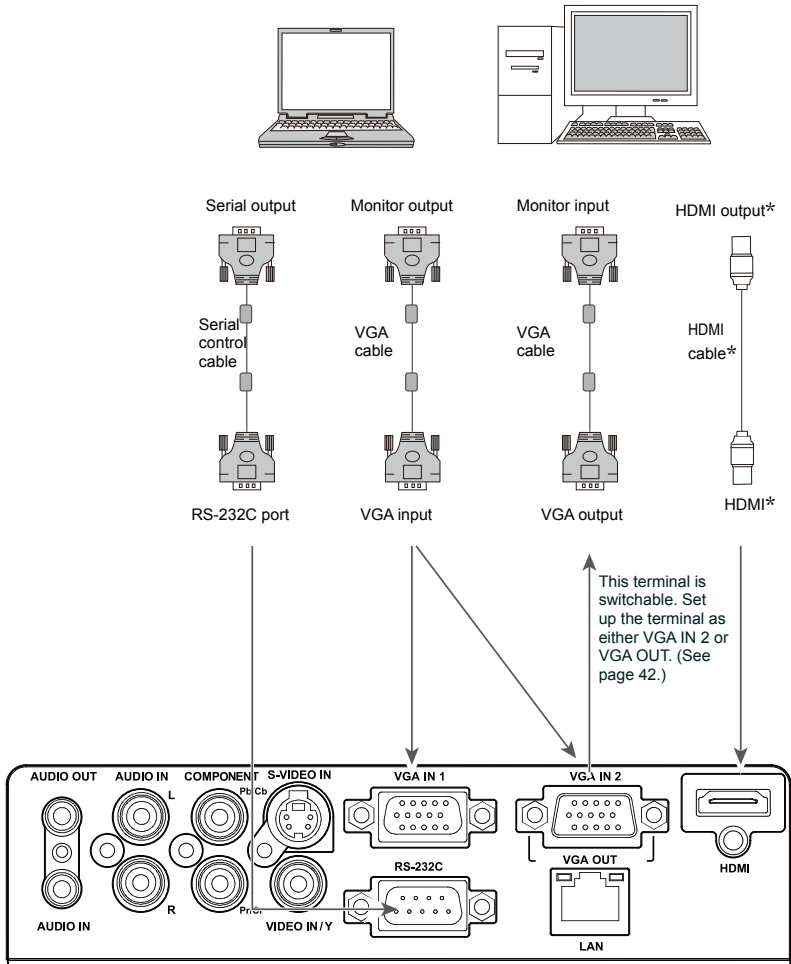

**Some model doesn't support this function.*



Unplug the power cords of both the projector and external equipment from the AC outlet before connecting the cables.

Connecting to video equipment (Video, S-Video)

Cables used for connection:(Cables are not supplied with the projector)

- Video cable
- S-Video cable
- RCA cable
- Audio cable

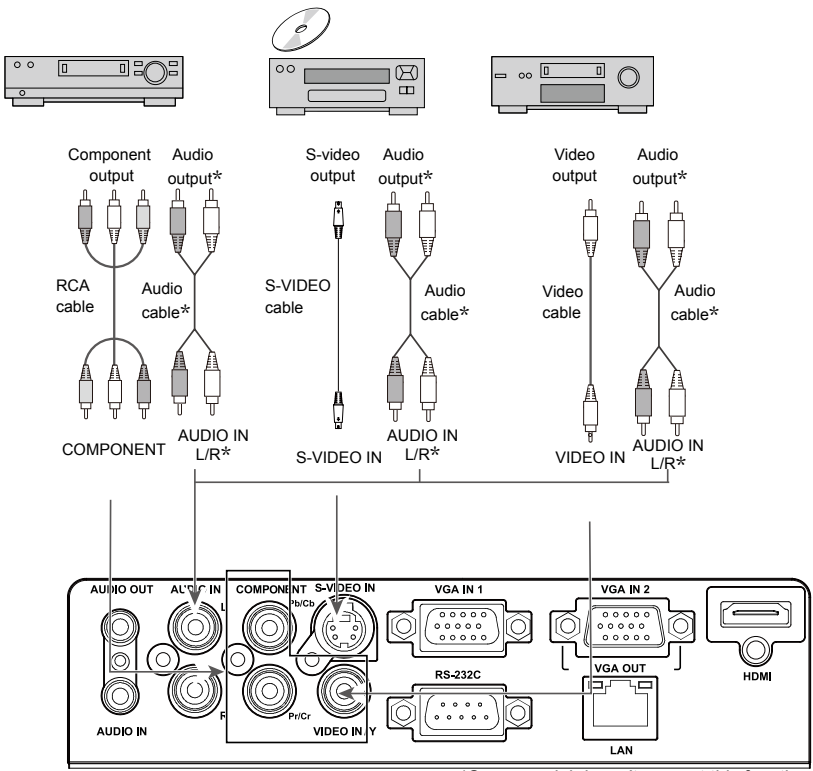

**Some model doesn't support this function.*

! *Unplug the power cords of both the projector and external equipment from the AC outlet before connecting the cables.*

Installation

Connecting to audio equipment

Cables used for connection:

- Audio cable (Cables are not supplied with the projector)

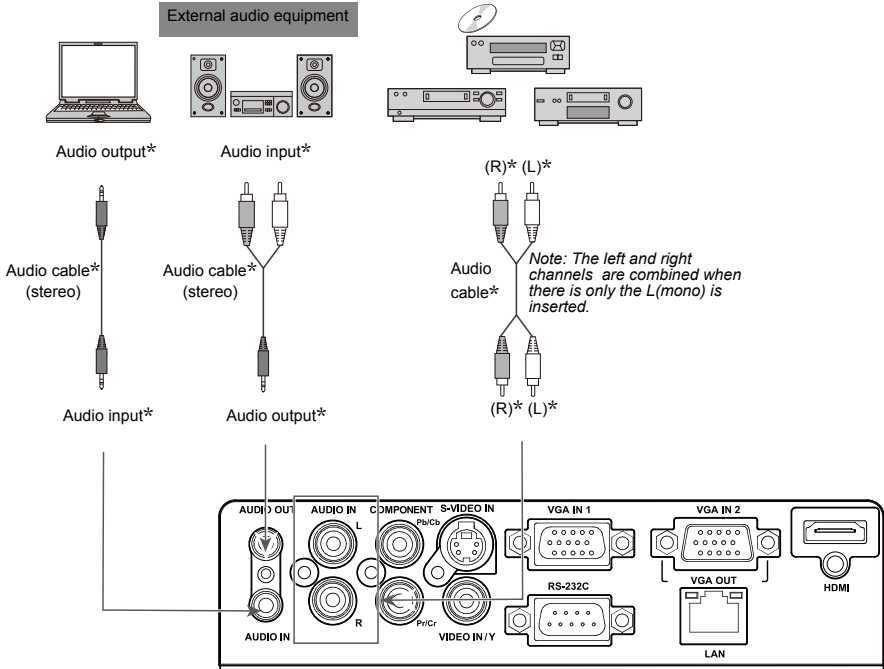

**Some model doesn't support this function.*



Unplug the power cords of both the projector and external equipment from the AC outlet before connecting the cables.

Connecting the AC power cord

This projector uses nominal input voltages of 100–240V AC and it automatically applies to different input voltages. It is designed to work with a single-phase power system having a grounded neutral conductor. To reduce the risk of electrical shock, do not plug into any other type of power system. If you are not sure of the type of power being supplied, consult your authorized dealer or service station. Connect the projector with all peripheral equipment before turning it on.

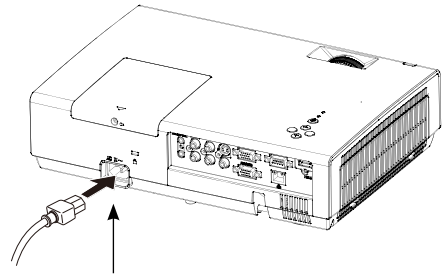

Connect the AC power cord to the projector.



Note:

The AC outlet should be near this equipment and must be easily accessible.

✓ Note:

For safety, unplug the AC power cord when the projector is not in use. When the projector is connected to an outlet with AC power cord, it is in stand-by mode and consumes a little electric power.

Note on the power cord

AC power cord must meet the requirements of the country where you use the projector. Confirm the AC plug type with the chart below and proper AC power cord must be used. If the supplied AC power cord does not match.

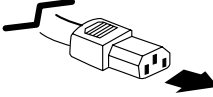
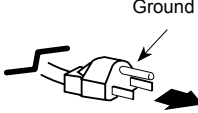
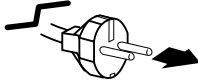
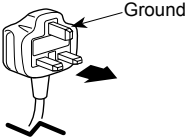
| Projector side | AC outlet side | | |
|---|--|---|---|
| | For the U.S.A. and Canada | For Continental Europe | For the U.K. |
|  <p>To power cord connector on your projector.</p> |  <p>Ground</p> <p>To the AC outlet. (110 V AC)</p> |  <p>To the AC outlet. (200 - 240 V AC)</p> |  <p>Ground</p> <p>To the AC outlet. (200 - 240 V AC)</p> |

✓ Note:

- Using incorrect power cord may influence the product performance, or even cause hazards like an electric shock or fire. To ensure the product performance and security, please apply the cable of the same model with the original one.
- Common connecting cables include the AC power cord, various VGA cables, video cable, and serial control cable.

Basic operation

Turn on the projector

1. Complete peripheral connections (with a computer, VCR, etc.) before turning on the projector.
2. Connect the projector's AC power cord into AC outlet. The POWER indicator turns red.
3. Press the POWER button on top control or on the remote control. The POWER indicator becomes green and the cooling fans start to work. The preparation display appears on the screen.
4. If the projector is locked with a PIN code, a PIN code input dialog box appears. Enter the PIN code as instructed below.

✓ Note:

- When the logo select is set to be "Off", the logo will not be displayed on the screen.

Enter a PIN code

Press OK button to input PIN code. Press ▲▼ button to select a number and press OK button to enter it to the PIN code box, then number changes to "*" and automatically move the cursor to next box. If you fixed an incorrect number, press MENU button to reset it again.

Repeat the step to complete entering a three-digit number.

After entering the three-digit number, will automatically move the cursor to "Set", press OK button so that you can start to operate the projector.

If you entered an incorrect PIN code, the "PIN code" and the number (***) turn red. PIN code will be reset within one second automatically, Enter the correct PIN code all over again.

What is PIN code?

PIN (Personal Identification Number) code is a security code that allows the person who knows it to operate the projector. Setting the PIN code can prevent unauthorized use of the projector. A PIN code consists of a three-digit number. Refer to the PIN code lock function in the "Expand" "Security" menu on pages 44 for PIN code lock operation of the projector.

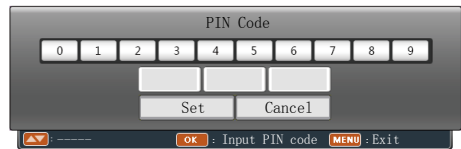

Move the cursor to OK, and press OK.



Caution on handling the PIN code
If you forget your PIN code, the projector can not longer be started. Take a special care in setting a new PIN code. Write down the number in a column on page 65 of this manual and keep it properly. Should the PIN code be missing or forgotten, consult your dealer or service center.

Turn off the projector

1. Press the POWER button on top control or on the remote control, and "Power off?" appears on the screen.
2. Then, press the POWER button again in 4 seconds. The POWER indicator starts to flash red, and the cooling fans keep running (You can select the level of fans' quietness and running speed.). Now you can unplug the AC power cord even if the fans are still running.
- 3 When the projector has cooled down enough to be turned on again, the POWER indicator stops flashing.

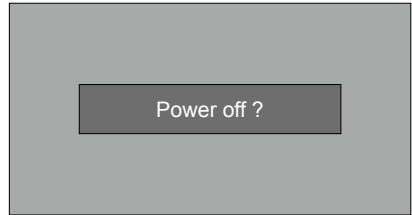

"Power off ?" disappears after 4 seconds.



To maintain the lamp life, once you turn the projector on, wait at least 5 minutes before turning it off.



Do not operate the projector continuously without rest. Continuous use may result in shortening the lamp life. Turn off the projector and let it stand for about an hour in every 24 hours.

✓ **Note:**

- *When the On start function is "On", this projector is turned on automatically by connecting the AC power cord to an AC outlet.*
- *The running speed of cooling fans is changed according to the temperature inside the projector.*
- *Do not put the projector in a case before it is cooled enough.*
- *If the POWER indicator flashes or emits a red light, see "Power Indicator".*
- *While the POWER indicator is flashing, the lamp is being cooled down and the projector cannot be turned on. Wait until the POWER indicator turns red to turn on the projector again.*
- *The fan rotation will terminate directly if the AC power cord is unplugged immediately after the projector is turned off.*
- *The projector can be turned on after the POWER indicator turns red. The waiting time to restart will be shortened when the normal power-off processing for fan cooling is completed, comparing with the time the AC power cord is immediately unplugged after the power-off.*

Basic operation

How to operate the screen menu

The projector can be adjusted or set via the on-screen menu. Each main menu can be divided into several levels of submenus, and submenus are also divided into several levels of sub-submenus.

For each adjustment and setting procedure, refer to the respective sections in this manual.

Top control

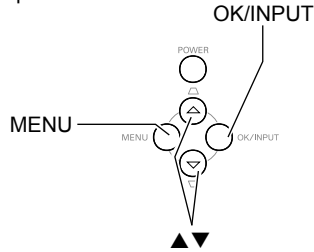

Remote control

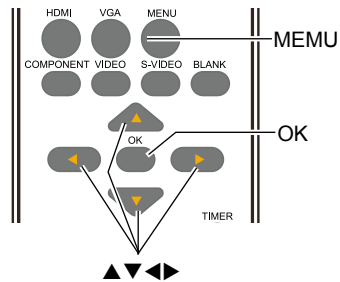

- 1 Press the MENU button on the top control or the remote control to display the screen menu.
- 2 Press ▲▼ buttons to select an entry in the main menu and then press OK button to enter the submenu.
- 3 Press ▲▼ buttons to select your required item, and then press OK button to set or enter required item.
- 4 Press ▲▼ buttons to adjust settings or switch among the items. Press the OK button for corresponding operation and then press MENU button return to the submenu.
- 5 Press MENU button to return to the previous menu. Press MENU button again to exit the screen menu.

Screen menu



Menu bar

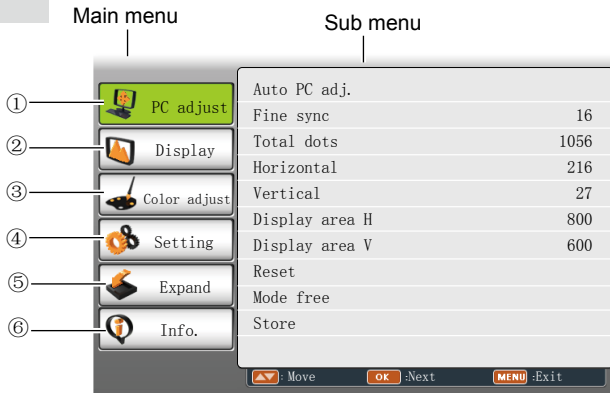

① **PC adjust**

Adjust computer parameters to match with VGA input signal format: **auto PC adj, Fine sync, Total dots, Horizontal, Vertical, Display area H, Display area V.**

② **Display**

- Screen Size: select the projecting image screen size.
If a computer is selected as a signal source, the following setup options for the image size are available: **Normal, Wide, Custom.**
If video equipment is selected as a signal source, the following setup options for the image size are available: **Normal, Wide or Custom.**
- Keystone: select keystone function to correct image keystone distortion.
- Project Mode: select a project mode among **Front, Rear, Ceiling/Front** and **Ceiling/Rear.**
- Menu Position: set the menu's position on the screen.
- Background Display: set the background display color for project screen.
- System: select a system signal format to match the input source.

③ **Color adjust**

- Image mode: the available image modes is **Normal, Natural, Cinema, Blackboard (green), Colorboard or User Image.**
- Image color adjust:
If a computer is selected as a signal source, the following image adjusting options are available: **Contrast, Brightness, Color temp., White balance (R/G/B)** and **Sharpness.**
If video equipment is selected as a signal source, the following image adjusting options are available: **Contrast, Brightness, Color, Tint, White balance (R/G/B), Sharpness** and **Progressive.**

④ **Setting**

Configure basic operation settings of the projector: **On start, Standby mode, High land, Lamp control, Cooling fast, Closed caption, Key lock, Iris, Terminal** and **Sound.**

⑤ **Expand**

Configure expand operation settings of the projector: **Language, Auto setup, Logo, Security, Power management, Filter counter, Pattern, Network** and **Factory default.**

⑥ **Info.**

Display the system information of the projector.

Basic operation

Adjust zoom and focus

Rotate the zoom ring to zoom in or zoom out the image.

Rotate the focus ring to adjust the focus of the image.

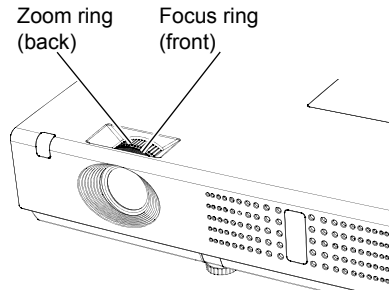

Auto setup function

This function is available just by pressing the AUTO button on the remote control. The system then automatically performs various settings in the setup menu, including input source search and auto pc adjust.

Remote control

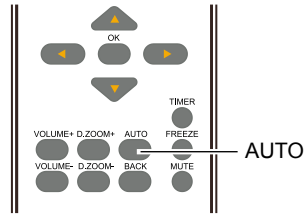

Volume

Direct operation

VOLUME

Press the VOLUME +/- button on the remote control to adjust the volume.

MUTE

Press the MUTE button on the remote control and select **On** to turn off the audio temporarily. To restore the audio to its previous level, press the MUTE button again and select **Off** or press the VOLUME +/- buttons.

Mute function is also effective for AUDIO OUT jack.

Remote control

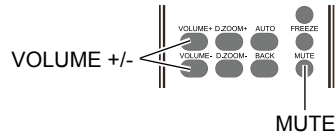

Menu operation

1 Press the MENU button to display the screen menu. Press ▲▼ button to select the Setting menu icon. Press OK to enter the submenu entry.

2 Press ▲▼ button to select Volume and then press OK button.

3 Press ▲▼ button to select Volume or Mute to adjust.

Volume

Press ▲ to increase the volume and ▼ to decrease the volume.

Mute

Press ▲▼ button to switch the mute function On/Off.

Volume menu



Basic operation

Remote control operation

Using the remote control for some frequently used operations is advisable. Just pressing one of the buttons enables you to make the desired operation quickly without calling up the screen menu.

INPUT

Press INPUT button on the remote control to select the input source.

FREEZE

Press FREEZE button to freeze the picture on the screen. To cancel the freeze function, press the FREEZE button again or press any other button.

MUTE

Press MUTE button on the remote control to turn off the volume. Press MUTE button again or any other buttons to cancel mute function.

VOLUME +/-

Press image VOLUME +/- button on the remote control to increase or decrease the volume.

Remote control

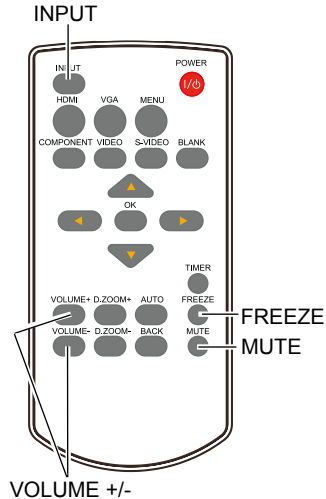

✓ *Note:*

See the next page for the description of other buttons.

BLANK

Press BLANK button to black out the image.
To restore to normal, press the BLANK button again or press any other button.

The screen changes each time you press the button as follows:

Black out → Normal → Black out → Normal ...

TIMER

Press TIMER button. The timer display "00:00" appears on the screen and the timer starts to count time (00:00–59:59).

To stop the Timer, press TIMER button again, and then the Timer display disappears.



"Blank" disappears after 4 seconds if there is no other button operation.



Timer display

D.ZOOM+

Press D.ZOOM+ button, the on-screen menu will disappear, while the information on digital zoom + appears. You can press Select to zoom in the image size, and press ▲▼◀▶ to move the image horizontally and vertically.

The moving is effective only when the image is larger than the size of the screen.

D.ZOOM-

Press D.ZOOM- button, the on-screen menu will disappear, while the information on digital zoom - appears. Press OK button to zoom in the image size.

To exit the "digital zoom +/-" mode, press any button except the D.ZOOM+/- and the OK button.

To return to normal size, select "Screen size" in "Display" menu to adjust screen size, or Press ▲▼◀▶ button to move the image horizontally or vertically.

Remote control

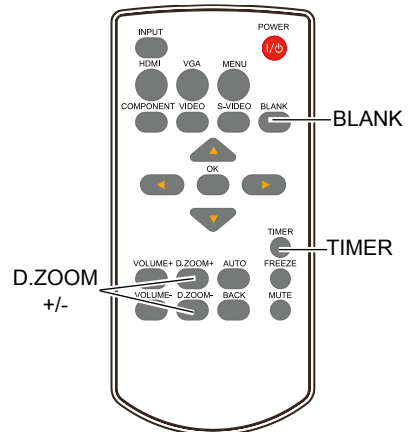

Input select

Direct Operation

Press HDMI, VGA, COMOPNENT, S-VIDEO or VIDEO button to select HDMI, VGA IN, Component, S-video or Video as input source.

Top control

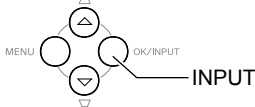

Menu operation

- 1 Press MENU button on the remote control or top control to display the input select menu.
- 2 Press ▲▼ button to select HDMI,VGA IN, Component, S-video or Video , then press OK button.

HDMI

When input source is from equipment connected to HDMI terminal with HDMI cable, please select HDMI. (Some model doesn't support this function.)

VGA IN 1

When input source is from computer connected to VGA IN 1 terminal with VGA cable, please select VGA IN 1.

VGA IN 2

When input source is from computer connected to VGA IN 2/VGA OUT terminal with VGA cable, please select VGA IN 2.

Component

Select it when the input source is from the video equipment connected to COMPONENT terminal with a RCA cable.

S-video

Select it when the video input signal is connected to S-VIDEO terminal.

Video

Select it when the video input signal is connected to VIDEO IN terminal.

✓ Note:

- When the Input Search function is set to On in the Auto setup function, the input signal will be searched automatically.
- When VGA IN 2/VGA OUT terminal is used as VGA OUT, VGA IN 2 can not be selected.

Remote control

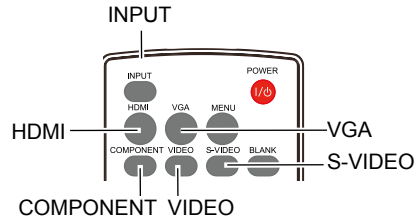

Input select menu



PC Adjust

Auto PC adj.

Auto PC Adjustment function is provided to automatically adjust Fine sync, Total dots, Horizontal and Vertical to conform to your computer.

Menu operation

Auto PC adj.

- 1 Press MENU button on the remote control to display screen menu. Press ▲▼ button to select PC adjust, then press OK button.
- 2 Press ▲▼ button to select Auto PC adj., then press OK button.

PC adjust Menu

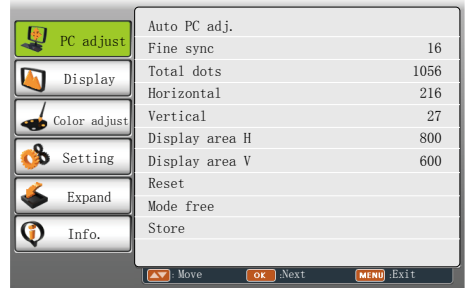

Store

The system parameters adjusted in the Auto PC adj. can be stored in the projector.

√ Note:

- Total dots and horizontal & vertical positions of some computers cannot be fully adjusted with this Auto PC adj. function. When the image is not provided properly with this function, manual adjustments are required.
- The Auto PC adj. cannot be operated when 480i, 576i, 480p, 576p, 720p, 1035i, or 1080i is selected in the System menu of computer inputx.

PC Adjust

Manual PC adj.

Some computers employ special signal formats which may not be tuned by Multi-scan system of this projector. Manual PC Adjustment is provided for you to precisely adjust several parameters to match those signal formats. The projector has five independent memory areas to store those parameters manually adjusted, which allows you to recall the setting for a specific computer.

- 1 Press MENU button on the remote control to display screen menu. Press ▲▼ button to select PC adjust, then press OK button.
- 2 Press ▲▼ button to select the item you want to adjust, then ▲▼ button to adjust the data.

Fine sync

Press ▲▼ buttons to adjust the value, eliminating a flicker from the image displayed (from 0 to 31).

Total dots

Press ▲▼ buttons to adjust the number of total dots in one horizontal period to match your PC image.

Horizontal

Press ▲▼ to adjust the horizontal picture position.

Vertical

Press ▲▼ to adjust the vertical picture position.

Display area H

Press ▲▼ to adjust the horizontal area displayed by the projector.

Display area V

Press ▲▼ to adjust the vertical area displayed by the projector.

Reset

To reset the adjusted data, select Reset and press OK. A confirmation box appears and then select Yes. All adjustments will return to their previous figures.

Mode free

To clear the adjusted data, select Mode free and then press ▼ or OK. Move ▼ or OK to highlight the Mode you want to clear and then press OK.

Store

To store the adjusted data, select **Store** and then press ▼ or OK. Move the red arrow indicator to one of the Mode 1 to 5 in which you want to store, and then press OK.

Manual PC adj. menu

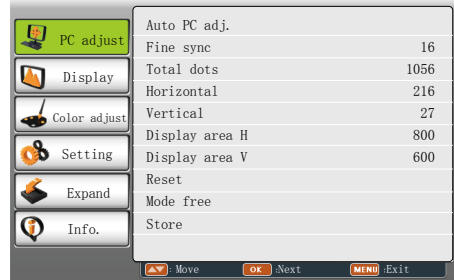

√ Note:

If you select 480i, 576i, 480p, 576p, 720p, 1035i or 1080i from the system menu, the functions of both horizontal image and vertical image will be disabled.

Display

Following items can be set in Display menu: Screen Size, Keystone, Project Mode, Menu Position, Background Display and System.

Screen Size

The screen size can be reset to the value as you desire.

- 1 Press MENU button on the remote control to display screen menu. Press ▲▼ button to select Display, then press OK button.
- 2 Press ▲▼ button to select Screen Size, press OK button.
- 3 Press ▲▼ button to select the size you desire, and then press OK button.

Normal

To project images in the same aspect ratio with the input signals.

Wide

Provide an image with an aspect ratio of 16:9 by expanding the image width uniformly.

Custom

Adjust the proportion and position of the screen manually.

Press OK button at Custom, Custom menu appears on the screen. Press ▲▼ button to adjust your required item.

H/V scale: Adjust the horizontal/vertical screen scale.

H&V: When set to "On", the aspect ratio is fixed. The Scale V appears dimmed and becomes unavailable. Adjust Scale H, and then the screen scale is automatically modified based on the aspect ratio.

H/V position: Adjust the horizontal/vertical screen position.

Common: Save the adjusted scale to all the inputs. Press OK at Common to display a confirmation box. To save the scale, press OK. When Custom is selected, the saved scale is used.

Reset: Reset all the adjusted values. Press OK at Reset to display a confirmation box. To set, press OK at "Yes".

✓ Note:

To obtain perfect image quality, please set the display resolution as XGA(1024x768) or WXGA(1280x800).

Display menu

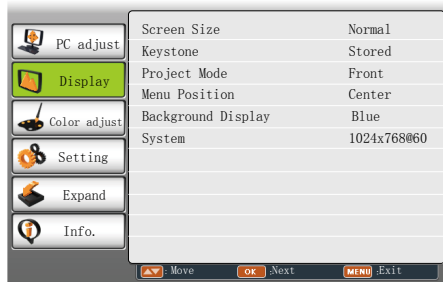

Screen Size

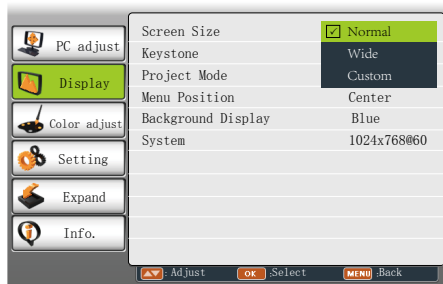

Display

Keystone

This function is used to store or reset the keystone correction when the AC power cord is unplugged.

- 1 Press MENU button on the remote control to display screen menu. Press ▲▼ button to select Display, then press OK button.
- 2 Press ▲▼ button to select Keystone, press OK button.
- 3 Press ▲▼ button to select the item you want to set, press OK button.

- Reset ...Reset the keystone correction when the AC power cord is unplugged.
- Store ...Store the keystone correction even when the AC power cord is unplugged.
- Adjust ..Press OK for keystone correction. Keystone correction menu appears on the screen. Press ▲▼ to correct keystone distortion.

Keystone menu

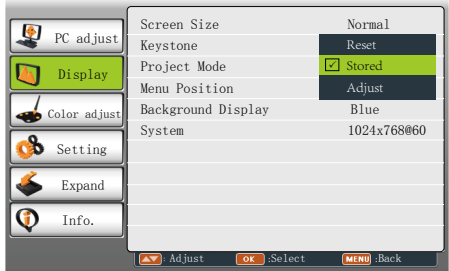

Project Mode

This function is used to set the project mode.

- 1 Press MENU button on the remote control to display screen menu. Press ▲▼ button to select Display, then press OK button.

- 2 Press ▲▼ button to select Project Mode, press OK button.
- 3 Press ▲▼ button to select the item you want to set, press OK button.

- Front.....Project to front screen when projector is front standing.
- Rear.....Project to rear screen when projector is front standing.
- Ceiling/Front....Project to front screen when projector is in ceiling state.
- Ceiling/Rear....Project to rear screen when projector is in ceiling state.

Project mode menu

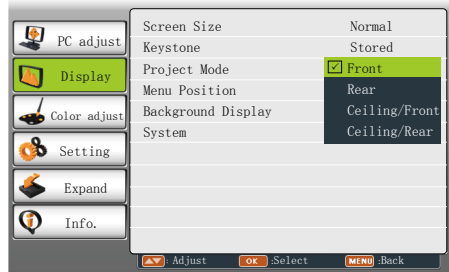

Menu Position

You can use this function to change the position of screen menu.

- 1 Press MENU button on the remote control to display screen menu. Press ▲▼ button to select Display, then press OK button.
- 2 Press ▲▼ button to select Menu Position, press OK button.
- 3 Press ▲▼ button to select the item you want to set, press OK button.

Upper left....Menu locates on upper left of the screen.

Upper right..Menu locates on upper right of the screen.

Center.....Menu locates at the center of the screen.

Lower left....Menu locates on lower left of the screen.

Lower right..Menu locates on lower right of the screen.

Menu position

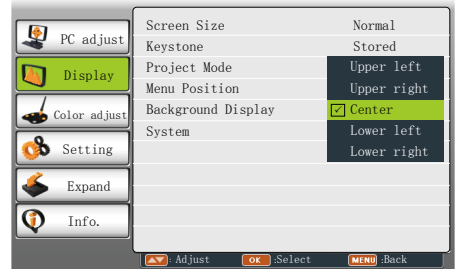

Background Display

This function is used to select the screen background of the projector when there is no signal detected.

- 1 Press MENU button on the remote control to display screen menu. Press ▲▼ button to select Display, then press OK button.
- 2 Press ▲▼ button to select Background Display, press OK button.
- 3 Press ▲▼ button to select the item you want to set, press OK button.

Black....Select black background.

Blue.....Select blue background.

Background display

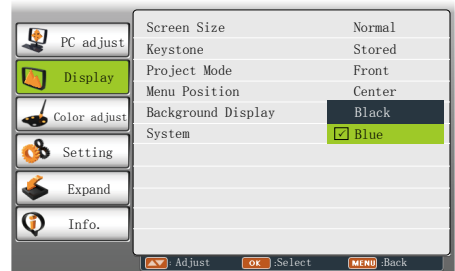

Display

System

Computer system select

The projector automatically tunes to various types of computers with its function of Multi-scan system and Auto PC Adjustment. If a computer is selected as a signal source, the projector automatically detects the signal format and tunes to project proper images without any additional setting.

One of the following messages may appear when:

Auto When the projector cannot recognize the connected signal conforming to the provided computer system, Auto is displayed on the System menu box and the Auto PC Adj. function works to display proper images. If the image is not projected properly, a manual adjustment is required.

----- There is no signal input from computer. Check the connection between your computer and projector.

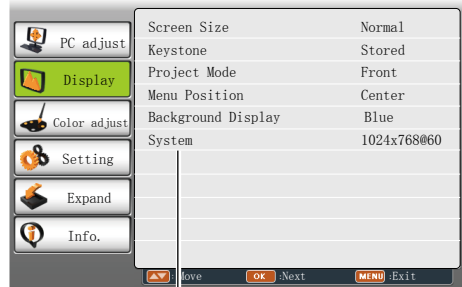

System

Select computer system manually

The system can also be selected manually.

- 1 Press MENU button on the remote control to display the screen menu. Press ▲▼ button to select the Display icon, and press OK button.
- 2 Press ▲▼ button to select System and press OK button.
- 3 Press ▲▼ button to select your required system, and then press the OK button.

System for computer signal

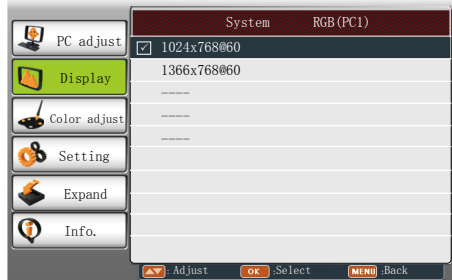

✓ Note:

When HDMI is selected, System menu for computer is disable.

Video or S-video

Auto

The projector automatically detects an incoming video system, and adjusts itself to optimize its performance. When Video System is PAL-M or PAL-N, select the system manually.

PAL/SECAM/NTSC/NTSC4.43/PAL-M/PAL-N

If the projector cannot reproduce proper video images, select a specific broadcast signal format from PAL, SECAM, NTSC, NTSC 4.43, PAL-M and PAL-N.

System for Video or S-video signal



Component

Auto

The projector automatically detects an input video system, and adjusts itself to optimize its performance.

Component video signal format

If the projector cannot reproduce proper video images, select a specific broadcast signal format from 480i, 576i, 480p, 576p, 720p, 1035i and 1080i.

System for Component signal



Color adjust

Color adjust menu is used to set the image mode and adjust the image.

Image Mode

Menu operation

- 1 Press MENU button on the remote control to display screen menu. Press ▲▼ button to select Color adjust, then press OK button.
- 2 Press ▲▼ button to select Image Mode, press OK button.
- 3 Press ▲▼ button to select the item you want to set, press OK button.

Normal

Image quality preset by the system on the projector.

Natural

For viewing images in a bright room.

Cinema

For watching movies with multiple gray scale levels.

Blackboard (Green)

For viewing the image projected on a blackboard (green) by enhancing the image quality. This is mainly effective on a green colored board instead of a black colored board.

Colorboard

For images projected onto the red, blue, yellow, or green wallpaper.

User Image

Image quality preset by the user in the Image adjustment menu.

Image mode (Computer)

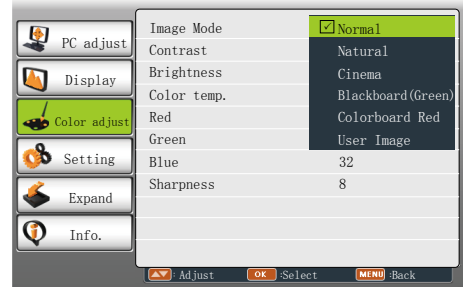
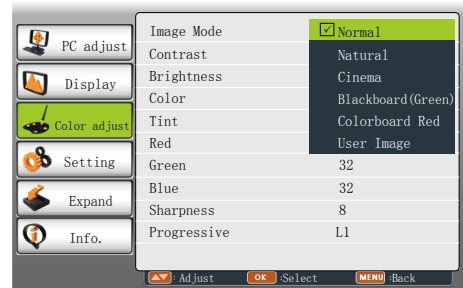

Image mode (Video, S-video, Component)



Color adjust(Computer)

- 1 Press MENU button on the remote control to display screen menu. Press ▲▼ button to select Color adjust, then press OK button.
- 2 Press▲▼ button to select the item you want to set, press OK button.
- 3 Press▲▼ button to adjust the data.

Contrast

Press ▼ to decrease the contrast and ▲ to increase it.

Brightness

Press ▼ to decrease the brightness and ▲ to increase it.

Color temp.

Press ▲▼ to select your desired color temperature.(Low, Mid and High)

Red(White balance)

Press ▼ to lighten the red tone and ▲ to deepen it.

Green(White balance)

Press ▼ to lighten the green tone and ▲ to deepen it.

Blue(White balance)

Press ▼ to lighten the blue tone and ▲ to deepen it.

Sharpness

Press ▼ to decrease the sharpness of an image and ▲ to increase it.

Color adjust(Computer)

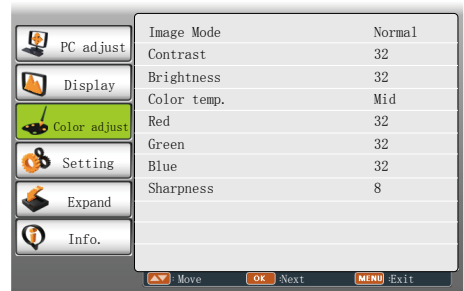

Color adjust

Color adjust (Video, S-video, Component)

- 1 Press MENU button on the remote control to display screen menu. Press ▲▼ button to select Color adjust, then press OK button.
- 2 Press ▲▼ button to select the item you want to set, press OK button.
- 3 Press ▲▼ button to adjust the data.

Contrast

Press ▼ to decrease the contrast and ▲ to increase it.

Brightness

Press ▼ to decrease the brightness and ▲ to increase it.

Color

Press ▼ to decrease the chroma and ▲ to increase it.

Tint

Press ◀▶ to select the appropriate tone for the image.

Red(White balance)

Press ▼ to lighten the red tone and ▲ to deepen it.

Green(White balance)

Press ▼ to lighten the green tone and ▲ to deepen it.

Blue(White balance)

Press ▼ to lighten the blue tone and ▲ to deepen it.

Sharpness

Press ▼ to decrease the sharpness of an image and ▲ to increase it.

Progressive

An interlaced video signal can be displayed in a progressive picture. Select one of the following options:

Off.....Disabled.

L1.....For an active picture.

L2.....For a still picture.

Film....For watching a film. With this function, the projector reproduces pictures faithful to the original film quality, reducing distortion.

Color adjust(Video, S-video, Component)

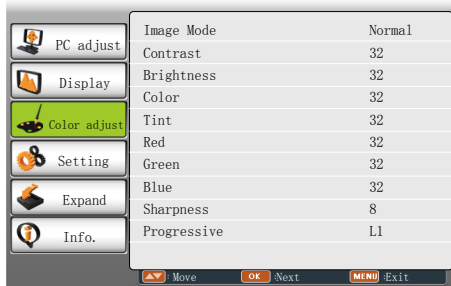

Setting

The projector has Setting menu that allows you to set the other various functions described as follows.

- 1 Press MENU button on the remote control to display screen menu. Press ▲▼ button to select Setting ,then press OK button.
- 2 Press▲▼ button to select the item you want to set, press OK button.
- 3 Press▲▼ button to adjust the item, then press OK button.

Setting menu



On start

Enable the projector to be turned on automatically just by connecting the AC power cord to an outlet when this function is set to On.

On start



Standby mode

Press▲▼ button to select the item below:

Eco.....In this state, network function, RS-232C and VGA OUT are disable after turning off the projetcor.

Normal ...Supply power to the projector even after turning off the projector.

You can turn on or turn off the projector via series port.

Standby mode



Setting

High land

Enable to control the fan through the Setting menu.

You can select the running speed of the fan according to the altitude of the location where the projector is installed.

Off.....Normal speed. Set it Off if the projector is operated at a lower altitude.

On.....Faster than Off. Set it On if the projector is operated at a higher altitude because fans will produce weaker effects.

✓ *Note:*

Please set High land "On" when operating the projector higher than 2000 meters.

High land



Lamp control

Change the brightness of the screen.

Normal.....Normal brightness.

Eco.....Lower brightness, reducing power consumption and extending the lamp life.

Lamp control

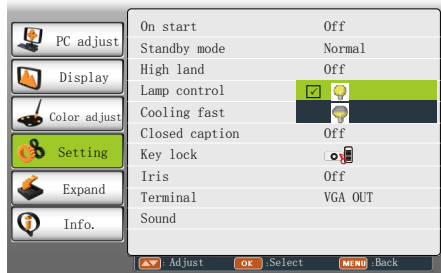

Cooling fast

This function provides the following options in the cooling fans' operation after turning off the projector.

Normal... Normal cooling speed.

60 sec ... Faster and louder than Normal, cooling time is shorter.

0 sec Enable you directly unplug the AC power cord after turning off the projector, no need waiting for cooling.

Cooling fast

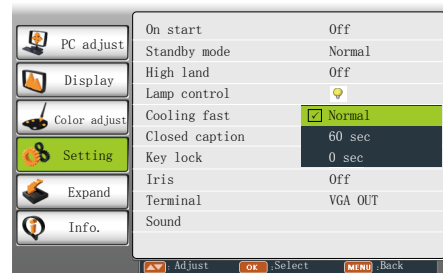

Closed Caption

Allows the subtitle to be displayed for the audio contents or other information. If the input source contains closed caption, you can enable this function and change the channel. Press ▲▼ to select OFF, CC1, CC2, CC3 or CC4.

✓Note:

- The icon of Closed Caption is displayed in grey when it is disable.
- Closed caption is disable when screen menu or Timer displayed on screen.

Closed Caption



Key lock

This function allows you to use the Key lock and PIN code lock function to set the security for the projector operation.

Select "Key lock" and press OK button, then press ▲▼ button to select the item you desire.

OffUnlock.

Projector Lock the operation of the top control. To unlock, use the remote control.

Remote ControlLock the operation of the remote control. To unlock, use the top control.

Key lock



If the top control accidentally becomes locked and you do not have the remote control nearby or there is something wrong with your remote control, contact the dealer where you purchased the projector or the service center.

Setting

Iris

This function is used to increase the contrast of the image.

On....Enable Iris function, increase the contrast of the image.

Off....Disable Iris function.

Iris



Terminal

The VGA IN 2/VGA OUT terminal can be used as computer input or monitor output. Press ▲ ▼ to select input or output.

VGA IN 2 VGA 2 input

VGA OUT.....Monitor out

Terminal



Sound

This item is used to adjust the volume.
Sound...Press ▲ button to increase the volume, press ▼ button to decrease the volume.

Mute....Press OK button to switch mute function.(On/Off)

Sound



Expand

The projector has Expand menu that allows you to set the other various expand functions described as follows.

- 1 Press MENU button on the remote control to display screen menu. Press ▲▼ button to select Expand ,then press OK button.
- 2 Press ▲▼ button to select the item you want to set, press OK button.
- 3 Press ▲▼ button to adjust the item, then press OK button.

Language

Press▲▼◀▶ button to select the language for screen manual.

This projector provides languages below:
English, Persian, Russian, Finnish, Dutch, Italian, Portuguese, French, German, Thai, Vietnamese, Japanese, Korean, Spanish, Indonesian, Turkish, Arabic, Afrikaans, Traditional Chinese, Simplified Chinese.

Auto setup

Press AUTO button on the remote control to execute Input search and Auto PC adj. functions.

Input search

Allows you to automatically detect input signals. It stops when a signal is found. Press ▲▼ button to select an option below:

Off.....Disabled.

On.....Enabled. This function is used to detect input signals automatically and stops when finding a signal.

Auto PC adj

On.....Press the AUTO button on the remote control to enable Auto PC adj. function automatically.

Off.....Cancel Auto PC adj. function.

Auto keystone

Off.....Disable auto keystone function.

Manual...Press the AUTO button on the top control or remote control to enable Auto keystone function.

Auto.....Correct keystone distortion according to the slope of the projector.

Expand menu

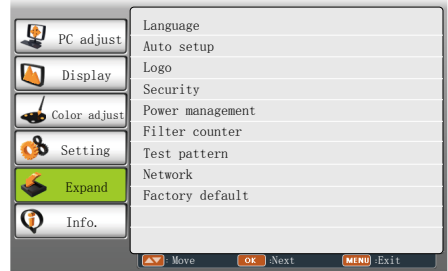

Auto setup

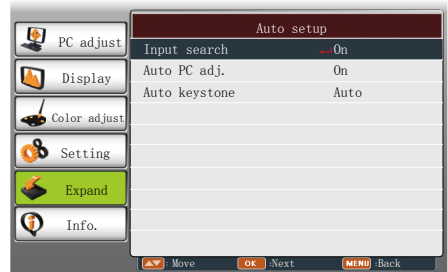

✓ Note:

- Only the last selected input source can be detected.
- If the INPUT button on the top control or on the remote control is pressed during Input search is in progress, Input search will stop and go back to the previous input signal.
- Input Search and Auto PC Adj. cannot be set Off at the same time.
- Fine sync., Total dots, Horizontal and Vertical position of some computers cannot be fully adjusted with the Auto PC Adj. function. When the image is not provided properly with this operation, manual adjustments are required.

Expand

Logo

This function allows you to customize the screen logo with Logo select, Capture, Logo PIN code lock and Logo PIN code change functions.

Logo Select

This function decides on the starting-up display from among following options.

- Default Show the factory-set logo.
- User.....Show the image captured by user.
- Off Show the countdown display only.

Capture

You can capture a projected image as start logo or interval of presentation.

Select Capture and press OK button. Confirmation dialog box appears, select "Yes" to start capturing.

You can set Logo Select as "User" after capturing, then captured image will appear on screen next time you start the projector.

Logo

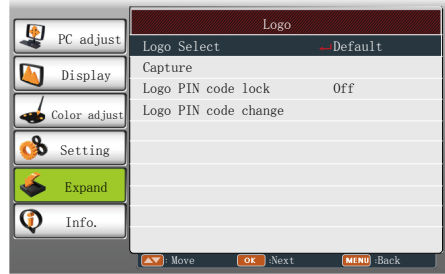

Logo PIN code Lock

This function prevents an unauthorized person from changing the screen logo.

- Off The screen logo can be changed freely from the Logo menu.
- On The screen logo cannot be changed without a Logo PIN code.

If you want to change the Logo PIN code lock setting, press OK button and the Logo PIN code dialog box appears. Enter a Logo PIN code by following the steps below.

Enter PIN code

Press ▲▼ button to select a number, and then press OK button to enter this number, automatically move the cursor to next box. If you fixed an incorrect number, press MENU button to reset it again.

Repeat this step to complete entering a three-digit number.

After entering the three-digit number, automatically move the cursor to "Set", and press OK button, then you can start to operate the projector.

If you entered an incorrect PIN code, the "PIN code" and the number (***) turn red, it will be reset automatically within one second. Enter the correct PIN code all over again.

Logo PIN code change

Logo PIN code can be changed to your desired three-digit number. Press OK button to select Logo PIN code change. Logo Pin code dialog box appears, press ▲▼ button to enter the correct code. The New Logo PIN code input dialog box appears. Set a new Logo PIN code, confirmation box appears, select Yes to set the new Logo Pin code.

Be sure to note the new Logo PIN code and keep it on hand. If you lost the number, you could no longer change the Logo PIN code setting.

Caution:

When you have changed the logo pin code, write down the new pin code in column of the logo pin code no. memo on page 65, and keep it securely. Should the logo pin code be lost or forgotten, the logo pin code setting can no longer be changed.

Security

This function allows you to use the PIN code lock and PIN code change functions to set the security for the projector operation.

PIN code lock

This function prevents the projector from being operated by unauthorized persons and provides the following setting options for security.

OffUnlocked.

On Enter the PIN code every time turning on the projector.If you want to change PIN code lock setting or PIN code,you must enter the PIN code. The original PIN code is "111".

If you want to change the PIN code lock setting, press OK button, then PIN code dialog box appears.

Enter PIN code

Press ▲▼ button to select a number, and then press OK button to enter this number, automatically move the cursor to next box. If you fixed an incorrect number, press MENU button to reset it again.

Repeat this step to complete entering a three-digit number.

After entering the three-digit number, move the cursor to "Set", and press OK button, then you can start to operate the projector.

If you entered an incorrect PIN code, the "PIN code" and the number (***) turn red, it will be reset automatically within one second. Enter the correct PIN code all over again.

Change Logo PIN code lock setting

Press ▲▼ button to select On or Off, then press OK button.

PIN code change

The PIN code can be changed to your desired three-digit number. Press ▲▼ button to select PIN code change. Pin code dialog box appears, Press ▲▼ button to enter the correct code. The New PIN code input dialog box appears. Set a new PIN code.

Security



Caution:

When you have changed the logo pin code, write down the new pin code in column of the logo pin code no. memo on Page 65, and keep it securely. Should the logo pin code be lost or forgotten, the logo pin code setting can no longer be changed.

Expand

Power management

For reducing power consumption as well as maintaining the lamp life, the Power management function turns off the projection lamp when the projector is not operated for a certain period. Select one of the following options:

Ready When the lamp has been fully cooled down, the POWER indicator changes to green blinking. In this condition, the projection lamp will be turned on if the input signal is reconnected or any button on the top control or remote control is pressed.

Shut down When the lamp has been fully cooled down, the power will be turned off.

Off Power management function is off.

Timer If the input signal is interrupted and no button is pressed for more than 30 seconds, the timer display with No signal appears. It starts the countdown until the lamp is turned off. Press ▲▼ button to set the Timer (1~30min.)

Ready countdown..Set the time that ready status transfers to standby status automatically. (0-30min. 0 Min: not transfer automatically)

In ready status, press POWER button to switch to standby status, and press any other button to turn on the projector.

Power management



Time left before Lamp is off.

✓ Note:

Factory default: "Ready: 5 min".

Power management

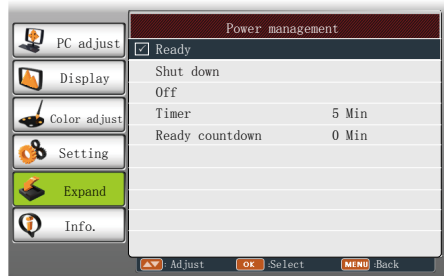

Filter counter

This function is used to set a frequency for filter cleaning.

When the projector reached a specified time between cleanings, a Filter warning icon appears on the screen, notifying the cleaning is necessary. After cleaning the filter, be sure to select RESET and set the timer. The Filter warning icon will not turn off until the filter counter is reset.

Filter counter.....The time that filter used.

Timer.....Frequency for filter cleaning.

Filter counter reset..Reset the filter counter.

Filter counter



Test Pattern

This function is used to set the internal test signal: Gray scale 1, Gray scale 2, Gray scale 3, Gray scale 4, Color bar, Red, Green, Blue, Cross hatch, White, Black and Gray.

Test Pattern

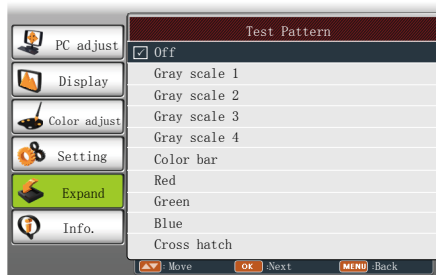

Network (Some model doesn't support this function.)

Function : PC controls projector via LAN.

Preparation:

1. Equipments: PC, projector, cables
2. Connection procedures:
Connect the projector to routers or switches of the LAN by direct or cross cable. If it fails to connect PC and projector by parallel cable, please switch to cross cable as suggested.
3. After the computer is booted and the projector is plugged in, indicator lights of LAN interface on will flash continuously.

Operation procedures:

- 1 Turn on the projector.
- 2 Obtain network address. DHCP set is displayed as On and obtain network address automatically. (If familiar with network, you can set DHCP as Off and obtain network address manually.)
- 3 Enter network settings menu.
 - (1) Press MENU button on the remote control to display screen menu. Press ▲▼ button to select Expand, then press OK button.
 - (2) Press ▲▼ button to select Network, and then press OK button to enter the network menu.



Expand

- (3) When DHCP is set On, IP address, Subnet, Gateway and DNS will be obtained automatically, press OK at "Set" to confirm the parameters.

When DHCP is set Off, press OK button to enter IP address, then press button to enter Subnet, Gateway and DNS respectively, press OK at "Set" to confirm the parameters.

Network setting

| | |
|------------|-----------|
| DHCP | On |
| IP address | |
| Subnet | |
| Gateway | |
| DNS | |

Set Cancel

Adjust Select Back

Network setting

| | |
|------------|---------------|
| DHCP | Off |
| IP address | 0 . 0 . 0 . 0 |
| Subnet | 0 . 0 . 0 . 0 |
| Gateway | 0 . 0 . 0 . 0 |
| DNS | 0 . 0 . 0 . 0 |

Set Cancel

Move Select Back

Factory default

This function returns all setting values except for the User logo, PIN code lock, Logo PIN code lock, Lamp counter and Filter counter to the factory default settings.

Information

The information menu is used to detect signal of projected image and running state.

Menu operation

Press MENU button on the remote control to display the screen menu. Press ▲▼ to select Info., then press OK button, the information menu will appear as the right picture.

The information below will display in information menu.

Input

The selected input source is displayed.

H-sync freq .

The horizontal frequency of the input signal is displayed in KHz or - - - -KHz when no signal.

V-sync freq .

The vertical frequency of the input signal is displayed in Hz or - - - - Hz when no signal.

Lamp status

Display the lamp mode you select.

Lamp counter

Display the time that lamp used.

Power management

Display the power management setting.

Image mode

Display the selected image mode.

Info. menu

| | |
|------------------|-------------|
| Input | VGA IN 1 |
| H-sync freq. | 1024x768@60 |
| V-sync freq. | 48.3 KHz |
| Lamp status | 59.9 Hz |
| Lamp counter | Lamp status |
| Power management | 16 H |
| Image Mode | Ready |
| | 5 Min |
| | Normal |

Network Control (Some model doesn't support this function.)

You can set and control the projector through network.

Connecting to the LAN

Connect the LAN cable to the LAN terminal of the projector.

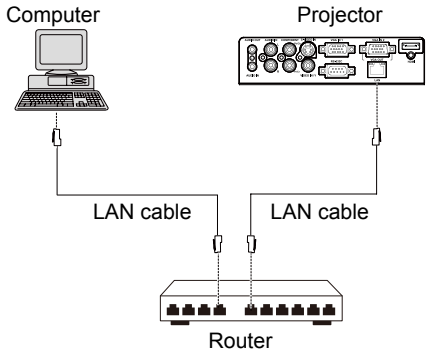

Computer operation

1. Turn on the computer.
2. Set the network parameters, refer to pages 46-47.
3. Set DHCP as On to obtain IP address automatically.

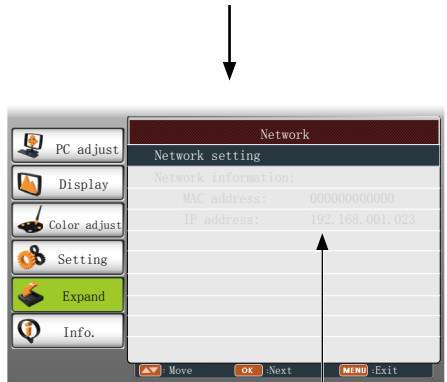
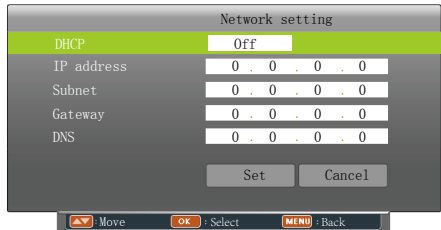

Webpage operation

1. Input IP address in address bar. Refer to page 50 for obtaining IP address.
2. Input ID and password,click OK to display the webpage.
Default ID: admin
Default password:admin
3. Set the items for projector in webpage.

Projector/Standby

This page displays the current power supply state of the projector.

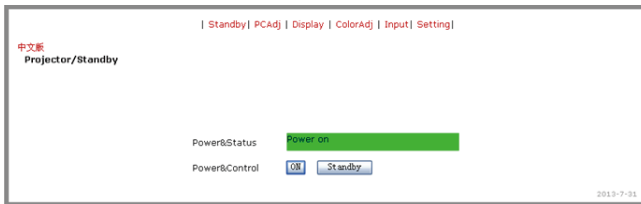

Projector/PCAdj

While connecting signal, you can use Auto PC Adjust function, adjust the value of Fine sync, Total dots, Horizontal and Vertical.

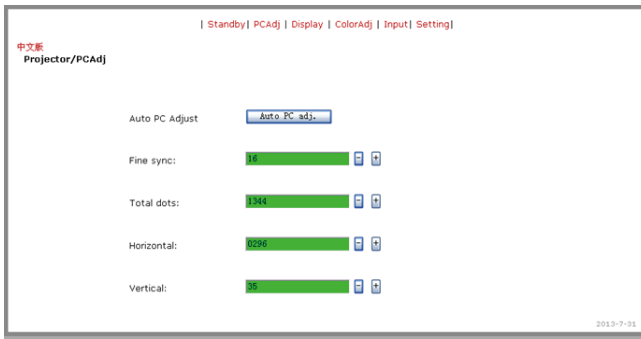

Projector/Display

This page displays Screen size, Menu position and Background.

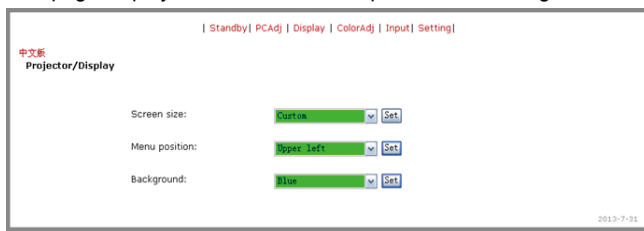

Projector/ColorAdj

You can select Image Mode, adjust value of Contrast/Brightness/Red/Green/Blue/Sharpness in this page.

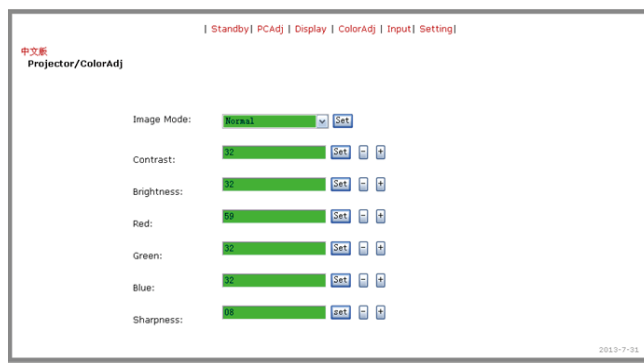

Projector/Input

You can select input source in this page.



Projector/Setting

You can set Input Search/Auto PC adj/On start/Lamp control/Blank/Freeze in this page.

The screenshot shows a web interface for projector settings. At the top, there are navigation links: | Standby | PCAdj | Display | Coloradj | Input | Setting |. Below this, the page title is "Projector/Setting" with a small "中文" icon. The settings are listed as follows:

| Setting Name | Current Value | Action |
|---------------|---------------|--------|
| Input Search: | Off | Set |
| Auto PC adj: | On | Set |
| On start: | Off | Set |
| Lamp control: | On | Set |
| Blank | Off | Set |
| Freeze | Off | Set |

In the bottom right corner of the interface, the date "2013-7-31" is displayed.

Maintenance and cleaning

POWER indicator

The POWER indicator shows the state of the function which protects the projector. Check the state of the POWER indicator to take proper maintenance.

The projector is shut down and the POWER indicator is flashing orange.

When the temperature inside the projector exceeds the normal temperature, the projector is automatically shut down to protect internal components. The POWER indicator is blinking while the projector is being cooled down. When the projector has cooled down enough (to its normal operating temperature), it can be turned on again by pressing the POWER button.

✓ **Note:**

The POWER indicator continues to blink even after the temperature inside the projector returns to normal. When the projector is turned on again, the POWER indicator stops blinking.

Check the items below:

- Did you provide appropriate space for the projector to be ventilated?
Check the installing condition to see if ventilation slots are not blocked.
- Has the projector been installed near the duct or vent of an airconditioning?
Move the installation of the projector away from the duct or vent.
- Are the air filters clean? Clean the air filters periodically.

The projector is shut down and the POWER indicator lights orange.

When the projector detects an abnormal condition, it is automatically shut down to protect the internal components and the POWER indicator lights orange. In this case, unplug the AC power cord and plug it, and then turn on the projector once again to verify operation. If the projector cannot be turned on and the POWER indicator lights red, unplug the AC power cord and contact the service station for servicing and maintenance.

POWER indicator

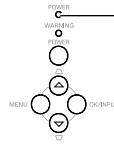

POWER indicator flashes orange.

POWER indicator

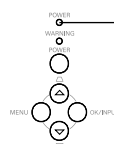

POWER indicator lights orange.



Caution

Do not leave the projector with the AC power cord connected under an abnormal condition. It may result in fire or electric shock.

Cleaning the filter

The air filter prevents dust from accumulating on the surface of the optical elements inside the projector. Should the air filter become clogged with dust particles, it will reduce cooling fans' effectiveness and may result in a buildup of internal heat and adversely affects the life of the projector. If the Filter warning icon appears on the screen, the air filter should be cleaned immediately. Clean the air filter following the steps below.

- 1 Turn off the projector, and unplug the AC power cord from the AC outlet.
- 2 Remove the air filter.
- 3 Gently clean the filter with a brush.
- 4 Reinstall the filter into the projector properly.

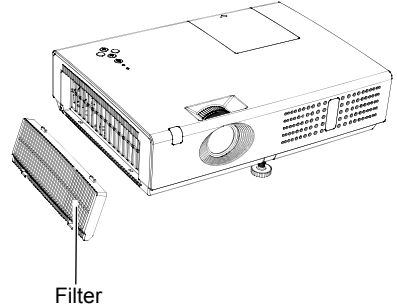

Caution

Do not operate the projector with the air filter removed. Dust may accumulate on the optical elements, degrading picture quality. Do not put any small objects into the air intake vents. Otherwise, it may result in malfunction of the projector.

Recommendation

We recommend avoiding dusty/smoky environments when you operate the projector. Usage in these environments may cause poor image quality. When you use the projector under dusty or smoky conditions, dust may accumulate on the lens, LCD panels, or optical elements inside the projector. When the symptoms above are noticed, contact your authorized dealer or service station for proper cleaning.

Filter counter reset

Be sure to reset the filter counter after cleaning or replacing the filter.

1. Press Menu on the remote control to display the screen menu. Press ▲▼ to select Expand, then press OK button.
2. Press ▲▼ to select Filter, and then press OK button.
Press ▲▼ to select Filter counter reset and press OK button, "Filter counter Reset?" appears on screen, select "Yes" to continue.
3. When another dialog box pops up, select "Yes" to reset the filter.

Maintenance and cleaning

Clean the project lens

Unplug the AC power cord before cleaning.

Gently wipe the projection lens with a cleaning cloth that contains non-abrasive camera lens cleaner, or use a lens cleaning paper or commercially available air blower to clean the lens.

Avoid using an excessive amount of cleaner. Abrasive cleaners, solvents, or other harsh chemicals might scratch the surface of lens.

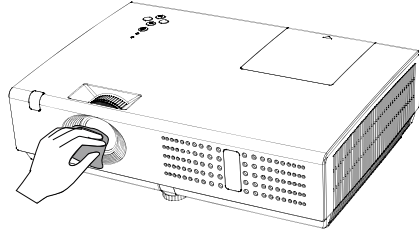

Clean the cabinet

Unplug the AC power cord before cleaning.

Gently wipe the projector surface with a soft dry cleaning cloth. When the cabinet is heavily soiled, use a small amount of mild detergent and finish with a soft dry cleaning cloth. Avoid using an excessive amount of cleaner. Abrasive cleaners, solvents, or other harsh chemicals might scratch the surface of the cabinet.

When the projector is not in use, put the projector in a pouch to protect it from dust and scratches.

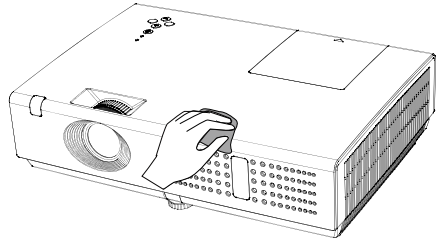

Replace the lamp

When the projection lamp of the projector reaches its end of life, the Lamp replacement icon appears on the screen, please replace the lamp immediately.

Lamp replacement icon

Lamp replace



As temperature inside the projector is high, you should cool the projector for at least 45 minutes before you open the lamp cover.



For the sake of safety, only use the lamp of the same model. Never drop the lamp onto the ground nor touch the glass bulb! The glass can shatter and hurt.



Note

When the lamp isn't illuminated, it may indicate that the lamp has been damaged. When you replace the lamp in a projector installed on the ceiling, you should stand beside the lamp cover but not under it; for the broken glass may fall down to hurt you. To do that, remove the lamp cover gently to avoid being hurt by the dropped glass. If glass drops into your eyes or mouth, you should see the doctor immediately.

To replace the lamp, follow the steps below:

1. Power off the projector and unplug the power cord. Then let the project cool for at least 45 minutes.
2. Loosen the screws on the lamp cover to remove the cover.
3. Make sure the lamp is well protected and remove three screws. Hold the handle to take out the lamp.
4. Install a new lamp with the same model and tighten the three screws. Make sure the installation is correct. Put lamp cover in place and then tighten the screw.
5. Plug the AC power cord and power on the projector.

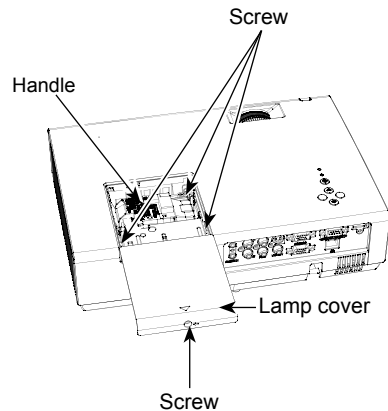



LAMP HANDLING PRECAUTIONS

This projector uses a high-pressure lamp which must be handled carefully and properly. Improper handling may result in accidents, injury, or create a fire hazard.

- Lamp life may differ from lamp to lamp and according to the environment of use. There is no guarantee of the same life for each lamp. Some lamps may fail or terminate their life in a shorter period of time than other similar lamps.
- If the projector indicates that the lamp should be replaced, i.e., if the WARNING indicator lights up, replace the lamp with a new one IMMEDIATELY after the projector has cooled down. (Follow carefully the instructions in the Lamp Replacement section of this manual.) Continuous use of the lamp with the WARNING indicator lighted may increase the risk of lamp explosion.
- A Lamp may explode as a result of vibration, shock or degradation as a result of hours of use as its lifetime draws to an end. Risk of explosion may differ according to the environment or conditions in which the projector and lamp are being used.

IF A LAMP EXPLODES, THE FOLLOWING SAFETY PRECAUTIONS SHOULD BE TAKEN .

If a lamp explodes, disconnect the projector's AC plug from the AC outlet immediately. Contact an authorized service station for a checkup of the unit and replacement of the lamp. Additionally, check carefully to ensure that there are no broken shards or pieces of glass around the projector or coming out from the cooling air circulation holes. Any broken shards found should be cleaned up carefully. No one should check the inside of the projector except those who are authorized trained technicians and who are familiar with projector service. Inappropriate attempts to service the unit by anyone, especially those who are not appropriately trained to do so, may result in an accident or injury caused by pieces of broken glass.

Appendix

Troubleshooting

Before calling your dealer or service center for assistance, check the items below once again.

- Make sure you have properly connected the projector to peripheral equipment.
- Make sure all equipment is connected to the AC outlet and the power is turned on.
- If the projector does not project an image when it is connected to a PC, restart the PC.

| Problems | Solutions |
|--|--|
| No power | <ul style="list-style-type: none">- Plug the power cord of the projector into the AC power outlet.- Check whether the POWER indicator lights red.- Only when the POWER indicator lights red you can power on the projector again.(Page 20)- Check the WARNING indicator. If it lights red, the projector can not be powered on.(Page 54)- Check the projection lamp.(Page 57)- Unlock the "Key lock" function.(Page 41) |
| No initial displaying | <ul style="list-style-type: none">- Make sure that Logo function is not set to "Off".(Page 44) |
| Initial displaying is inconsistent with factory defaults | <ul style="list-style-type: none">- Make sure that Logo function is not set to "User" or "Off".(Page 44) |
| Input signals are automatically switched (can't be switched) | <ul style="list-style-type: none">- Properly adjust the Input search function.(Page 43) |
| Ambiguous images | <ul style="list-style-type: none">- Adjust the focus.(Page 24)- Set a more proper projection distance.(Page 15)- Check whether the lens needs to be cleaned.(Page 56)- When moved from a environment with low temperature to the one with higher temperature, water will be condensed on the lens. If so, you have to wait till the condensed water disappears. |
| Image turns over leftward/ rightward | <ul style="list-style-type: none">- Check the function of "Ceiling/rear".(Page 32) |
| Image turns over upward/ downward | <ul style="list-style-type: none">- Check the function of "Ceiling".(Page 32) |
| Image not bright enough | <ul style="list-style-type: none">- Check whether the contrast or brightness is adjusted correctly.(Pages 37-38)- Check whether the Image mode is properly selected.(Page 36)- Check the lamp control function.(Page 40)- Check the WARNING indicator. If the indicator lights red, it means the service life of the lamp is over. You should replace the lamp with a new one of the same model immediately.(Page 61) |
| No image | <ul style="list-style-type: none">- Check the connection between computer or video equipment.(Pages 16-18)- Check with the signal from computer is correct. If connected to certain laptops, the settings of their video adapters need to be changed. You can refer to the operating instructions of the computer for such modification.- It takes 20 seconds to display an image after turning on the projector.(Page 20)- Check the input signal, color system, video system or computer system mode.- Make sure that the temperature doesn't exceed the permitted operating temperature(41°F-95°F[5°C-35°C]).- If BLANK function is enabled, no image will appear on the screen. You can press the BLANK button or other button on the remote control. |

Appendix

| | |
|--|--|
| No Sound | <ul style="list-style-type: none">- Check the audio cable connection from audio input source.- Adjust the audio source.(Page 25)- Press the VOLUME + button.(Page 25)- Press the Mute button.- When the AUDIO OUT is plugged in, the projector's built-in speaker is not available.- Is the image projected? The sound can only be heard when the image is projected. |
| The color is abnormal | <ul style="list-style-type: none">- Check the input signal, color system, video system or computer system mode.- Make sure that Blackboard is not selected in Image Mode menu. |
| Auto PC adj. function does not work. | - Check the Input signal. Auto PC adj. function can not work when 480p, 576p, 720p, 480i, 576i, 1035i or 1080i is selected.(Pages 34-35) |
| The Settings cannot be saved after turning off the projector. | - Make sure you selected "Store" after adjusting settings. |
| Power management function does not work. | - Power management function can not work while Freeze or Blank function is running.(Page 46) |
| Logo function does not work. | - Check connections and input source. |
| Auto setup function does not work. | <ul style="list-style-type: none">- Make sure no function in the Auto setup menu is set to "Off".(Page 43)- Make sure "On" is not chosen in the Ceiling function.(Page 32) |
| The image is distorted or disappears. | - Check and adjust "PC adjust" menu or "Screen size" menu. |
| PIN code dialog box appears at start-up | - PIN code lock is being set. |
| The remote control does not work. | <ul style="list-style-type: none">- Check the batteries.- Make sure no obstruction is between the projector and the remote control.- Make sure you are not too far from the projector when using the remote control. Maximum operating range is 5 m.- Unlock the Key lock function in the Setup menu for the remote control.(Page 41) |
| Indicators light or flash. | - Refer to Indicators and projector condition to check the status of the projector.(Page 61) |
| Exclamation mark appears on the screen. | - Your operation is invalid. Operate correctly. |
| Top control cannot be operated. | - Unlock the Key lock function in the Setup menu for the top control.(Page 41) |
| Unable to unlock the Logo PIN code, Key lock or PIN code lock. | - Contact the dealer or the service center. |















Warning:

High voltages are used to operate this projector, do not attempt to open the cabinet.

If the problem still exists after you take the aforesaid measures, you should contact the local distributor or the repair center and tell the machine model. We will tell you how to handle the issue.

Indicator and projector state

Check the indicator to know about the state of projector.

| Indicator | | State of projector |
|---|---|---|
| POWER (Green/Red) | WARNING (Red) | |
|  |  | The projector is off. (AC power cord not connected). |
|  |  | The projector is operating normally. |
|  |  | - In standby mode. Press POWER to power on the projector. - When the projector is cool enough, the temperature is restored to the normal value, you can turn on the projector. And the POWER indicator stops flashing. |
|  |  | Internal temperature too high and can't be turned on. When the projector is cool enough, the temperature is restored to the normal value and the POWER indicator lights red, you can turn on the projector . |
|  |  | In power management mode. |
|  |  | Ready for standby mode or the lamp is being cooled. Before you turn on the projector, you should wait till the lamp is cool enough and the POWER indicator flashes. |
|  |  | Can't be turned on because error is detected. You should unplug the power cord. Then insert it again and power on the projector. If the projector is powered off again, you should cut off the power and contact the local distributor or repair center. In this case, stop the projector. Otherwise, electric shock or fire may occur. |
| - |  | The service life of the lamp is over. You should replace it with a new one in time.* |

Green Red Orange Off

Green flashes Red flashes Orange flashes

* When the lamp reaches the end of its life, the WARNING indicator lights red. In this case, replace the lamp with a new one promptly.

Appendix

Compatible computer specifications

This projector can receive the signals below:

| Signal format | Resolution | Scanning frequency | | Dot Frequency (Mhz) | Signal | | | |
|--------------------|----------------|----------------------------|----------------------|---------------------|--------|-----------|------|---------------|
| | | horizontal frequency (Khz) | Field Frequency (Hz) | | RGB | Component | HDMI | Video/S-Video |
| NTSC/NTSC443/PAL-M | (720x487) | 15.734 | 59.940 | - | | | | o |
| PAL/PAL-N/SECAM | (720x576) | 15.625 | 50.000 | - | | | | o |
| 525i (480i) | 720x480i | 15.734 | 59.940 | 13.500 | | o | | |
| | 720(1440)x480i | 15.734 | 59.940 | 27.000 | | | o | |
| 625i (576i) | 720x576i | 15.625 | 50.000 | 13.500 | | o | | |
| | 720(1440)x576i | 15.625 | 50.000 | 27.000 | | | o | |
| 525p (480p) | 720x483 | 31.469 | 59.940 | 27.000 | | o | o | |
| 625p (576p) | 720x576 | 31.250 | 50.000 | 27.000 | | o | o | |
| 750 (720)/60p | 1280x720 | 45.000 | 60.000 | 74.250 | | o | o | |
| | | 44.955 | 59.940 | 74.176 | | | | |
| 750 (720)/50p | 1280x720 | 37.500 | 50.000 | 74.250 | | o | o | |
| | | 33.750 | 60.000 | 74.250 | | o | o | |
| 1125 (1080)/60i | 1920x1080i | 33.716 | 59.940 | 74.176 | | | | |
| | | 28.125 | 50.000 | 74.250 | | o | o | |
| 1125 (1080)/50i | 1920x1080i | 27.000 | 24.000 | 74.250 | | | | o |
| | | 26.973 | 23.976 | 74.176 | | | | |
| 1125 (1080)/24p | 1920x1080 | 28.125 | 25.000 | 74.250 | | | | |
| | | 33.750 | 30.000 | 74.250 | | | | |
| 1125 (1080)/25p | 1920x1080 | 33.716 | 29.970 | 74.176 | | | | |
| | | 67.500 | 60.000 | 148.500 | | | | o |
| 1125 (1080)/30p | 1920x1080 | 67.433 | 59.940 | 148.352 | | | | |
| | | 56.250 | 50.000 | 148.500 | | | | o |
| VGA | 640x480 | 31.469 | 59.940 | 25.175 | o | | o | o |
| | | 35.000 | 66.667 | 30.240 | o | | o | o |
| | | 37.861 | 72.809 | 31.500 | o | | o | o |
| | | 37.500 | 75.000 | 31.500 | o | | o | o |
| | | 43.269 | 85.008 | 36.000 | o | | o | o |
| SVGA | 800x600 | 35.156 | 56.250 | 36.000 | o | | o | o |
| | | 37.879 | 60.317 | 40.000 | o | | o | o |
| | | 48.077 | 72.188 | 50.000 | o | | o | o |
| | | 46.875 | 75.000 | 49.500 | o | | o | o |
| | | 53.674 | 85.061 | 56.250 | o | | o | o |
| MAC16 | 832x624 | 49.725 | 74.550 | 57.283 | o | | o | o |
| XGA | 1024x768 | 48.363 | 60.004 | 65.000 | o | | o | o |
| | | 56.476 | 70.069 | 75.000 | o | | o | o |
| | | 60.023 | 75.029 | 78.750 | o | | o | o |
| | | 68.678 | 84.997 | 94.500 | o | | o | o |
| MXGA | 1152x864 | 63.995 | 70.020 | 94.200 | o | | o | o |
| | | 47.776 | 59.870 | 79.500 | o | | o | o |
| 1280x768 | 1280x768 | 60.290 | 74.890 | 102.250 | o | | o | o |
| | | 68.630 | 84.840 | 117.500 | o | | o | o |
| | | 49.702 | 59.810 | 83.500 | o | | o | o |
| 1280x800 | 1280x800 | 62.795 | 74.934 | 106.500 | o | | o | o |
| | | 71.554 | 84.880 | 122.500 | o | | o | o |
| | | 60.000 | 60.000 | 108.000 | o | | o | o |
| MSXGA | 1280x960 | 63.981 | 60.020 | 108.000 | o | | o | o |
| | | 76.968 | 71.932 | 133.000 | o | | o | o |
| | | 79.977 | 75.025 | 135.001 | o | | o | o |
| | | 91.150 | 85.020 | 157.500 | o | | o | o |
| 1366x768 | 1366x768 | 47.720 | 59.799 | 84.750 | o | | o | o |
| SXGA+ | 1400x1050 | 65.317 | 59.978 | 121.750 | o | | o | o |
| UXGA | 1600x1200 | 75.000 | 60.000 | 162.000 | o | | o | o |
| WSXGA+ | 1680x1050 | 65.290 | 59.954 | 146.250 | o | | o | o |
| WUXGA | 1920x1200 | 74.038 | 59.950 | 154.000 | o | | o | o |

√ Note:

The specification is subject to change without any prior notice.

Configurations of terminals

COMPUTER IN 1/SCART, COMPUTER IN 2/MONITOR OUT

Terminal: Analog RGB (D-sub 15 pin)

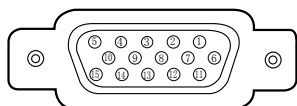

| | | | |
|---|--------------------------------|----|--|
| 1 | Red (Input/output) | 9 | ---- |
| 2 | Green (Input/output) | 10 | Grounding (field synchronizing) |
| 3 | Blue (Input/output) | 11 | Grounding |
| 4 | ---- | 12 | DDC data |
| 5 | Grounding (line synchronizing) | 13 | Horizontal synchronizing (compound sync.) input/output |
| 6 | Grounding (red) | 14 | Vertical synchronizing input/output |
| 7 | Grounding (green) | 15 | DDC Clock |
| 8 | Grounding (blue) | | |

CONTROL terminal (D-SUB-9 pin)

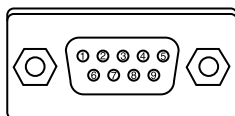

| | |
|---|------|
| 1 | ---- |
| 2 | RXD |
| 3 | TXD |
| 4 | ---- |
| 5 | GND |
| 6 | ---- |
| 7 | ---- |
| 8 | ---- |
| 9 | ---- |

LAN terminal

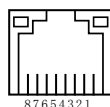

| | | | |
|---|------|---|------|
| 1 | TX + | 5 | ---- |
| 2 | TX - | 6 | ---- |
| 3 | ---- | 7 | RX + |
| 4 | ---- | 8 | RX - |

(Some model doesn't support this function.)

HDMI terminal (HDMI Type A 19 pin)

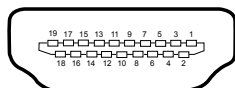

(Some model doesn't support this function.)

| | | | |
|----|-------------------|----|---------------------------|
| 1 | TMDS Data2+ | 11 | TMDS Clock Shield |
| 2 | TMDS Data2 Shield | 12 | TMDS Clock- |
| 3 | TMDS Data2- | 13 | CEC |
| 4 | TMDS Data1+ | 14 | Reserved (N.C. on device) |
| 5 | TMDS Data1 Shield | 15 | SCL |
| 6 | TMDS Data1- | 16 | SDA |
| 7 | TMDS Data0+ | 17 | DDC/CEC Ground |
| 8 | TMDS Data0 Shield | 18 | +5V Power |
| 9 | TMDS Data0- | 19 | Hot Plug Detect |
| 10 | TMDS Clock+ | | |

Content of hazardous substances and elements

| Name of parts | Hazardous substances and elements | | | | | |
|--|-----------------------------------|----|----|------|-----|------|
| | Pb | Hg | Cd | Cr6+ | PBB | PBDE |
| Optical parts ^{*1} | × | ○ | ○ | ○ | ○ | ○ |
| Electric parts ^{*2} | × | ○ | ○ | ○ | ○ | ○ |
| Cabinet, mechanical parts | × | ○ | ○ | ○ | ○ | ○ |
| Lamp unit | × | × | ○ | ○ | ○ | ○ |
| Batteries | ○ | ○ | ○ | ○ | ○ | ○ |
| Others (Remote control, cable and other parts) | × | ○ | ○ | ○ | ○ | ○ |

○: It means that contents of hazardous substances in all homogeneous materials in this part don't exceed "Required Limitations" specified in SJ/T11363-2006.

×: It means that contents of hazardous substances in at least one homogeneous material in this part exceed "Required Limitations" specified in SJ/T11363-2006.

Note:

*1: Optical parts includes optical lens, monitor, reflection lens ect.

*2: Electric parts includes PCB, internal wires, fans, power supply, sensors etc.

Appendix

Dimensions

Unit: mm

↘ Screw Holes for Ceiling Mount
Screw: M4
Depth: 10.0

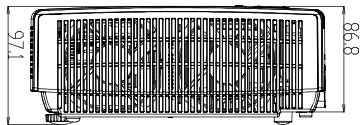
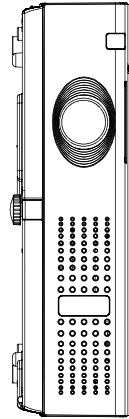
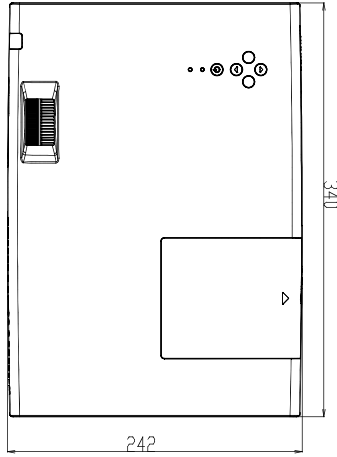
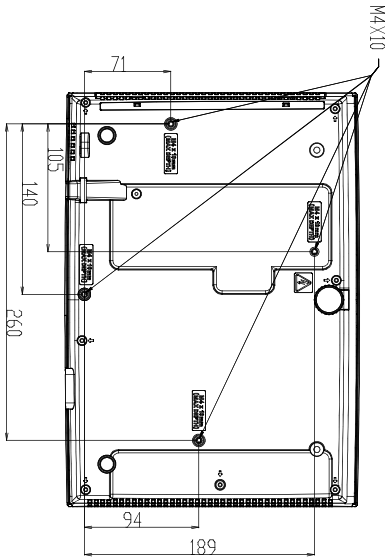
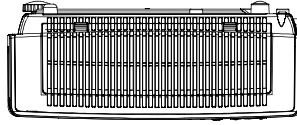

PIN code memorandum

Write down the PIN code in the blank below and keep it, please contact the repair center.

PIN code lock

Factory default PIN code 111*

| | | |
|--|--|--|
| | | |
|--|--|--|

Locking startup-animation PIN code

Factory default PIN code 111*

| | | |
|--|--|--|
| | | |
|--|--|--|

*If this 3-digit number is changed,
the factory default number will be ineffective.