



MimioPro G Interactive Display

User Manual – Aug 2023

Note : All the pictures in this manual are for reference only, subject to our available products.

To learn more, visit boxlight.com or call [866.972.1549](tel:866.972.1549).



Contents

Safety Warning..... 3

Placement..... 3

Power Supply..... 3

LED Screen General Care..... 4

Temperature 4

Humidity & Ventilation..... 4

Earphone 5

Standby 5

Battery 5

Cleaning Instructions 5

Power Switch Status 5

Control Panel 6

Terminal Interface..... 8

Remote Control..... 10

Remote Control Instructions 13

Range of Remote Control..... 14

Connections and Setting 14

Troubleshooting 17

Maintenance 22

Clean Screen 22

Clean Frame..... 22

Recommendation for Extended Breaks 22

Safety Warning

Before operating, please read this manual thoroughly, and keep it for future reference.

The images shown in this manual is indicative only. There may be differences between the pictures and the actual product, please prevail in kind.

Placement

- DO NOT put heavy objects on top of the unit.
- DO NOT put the unit near appliances that generate magnetic fields.
- DO NOT expose the unit to direct sunlight and other sources of heat.
- DO NOT place the unit on an unstable cart, stand, tripod, bracket, table, or shelf.
- DO NOT put any liquid near or on the unit, make sure do not spill any liquid inside the unit.

Power Supply

- Keep power cable from physical or mechanical damage.
- Check and ensure AC source is connected to the ground.
- This power cable comes with the device exclusively for this device only.
- Unplug power supply when the weather is thunderstorm or lightning.
- Check that the unit's operating voltage is identical with your local power supply.
- Use the original power cable from the accessory bag, don't modify or lengthen it.
- Unplug the power supply, when there is nobody home or the unit will be in idle for a long time.



LED Screen General Care

Unplug the power cable before cleaning.

Clean the screen with a soft, dustless, dry cloth.

For **deep clean**, please contact an authorized service center. Never use water or spray type detergent to clean the unit.

Never use any other hard or sharp object to replace the touch pen.

Better for the panel lifetime and the display performance, do not display high brightness image for long time.

Temperature

Normal operating temperature is 0 ~ 40°C.

Do not place the unit near or over a radiator or a heater.

If your unit is suddenly moved from a cold to a warm place, please unplug the power cable and do not turn it on for at least 2 hours, making sure the moisture inside the unit is all evaporated.

Humidity & Ventilation

Make sure indoor environment is dry and cool.

Normal operating humidity is 10%~90%RH.

To learn more, visit boxlight.com or call [866.972.1549](tel:866.972.1549).

Please put the unit in a well-ventilated place, so the heating can be released easily.
Ensure that the unit has enough space for ventilation. Space requirement: left, right and back >10cm, top > 20cm.

Earphone

- Before using earphones, please turn down the volume in advance.
- Using the earphone to listen to loud sound for a long time might affect the hearing.

Standby

- It will enter standby mode but not turn off the unit after pressing the standby key.
- Please make sure the battery gets properly disposed or recycled after use.

Battery

Please keep the battery away from kids and don't throw the battery into fire.
Caution risk of fire or explosion if the battery is replaced by an incorrect type.

Cleaning Instructions

There are vents on the back cover, please do not use any liquid or spray directly during cleaning.

Power Switch Status

“I” means power on, “O” means power off.

Control Panel

Prepare to install.

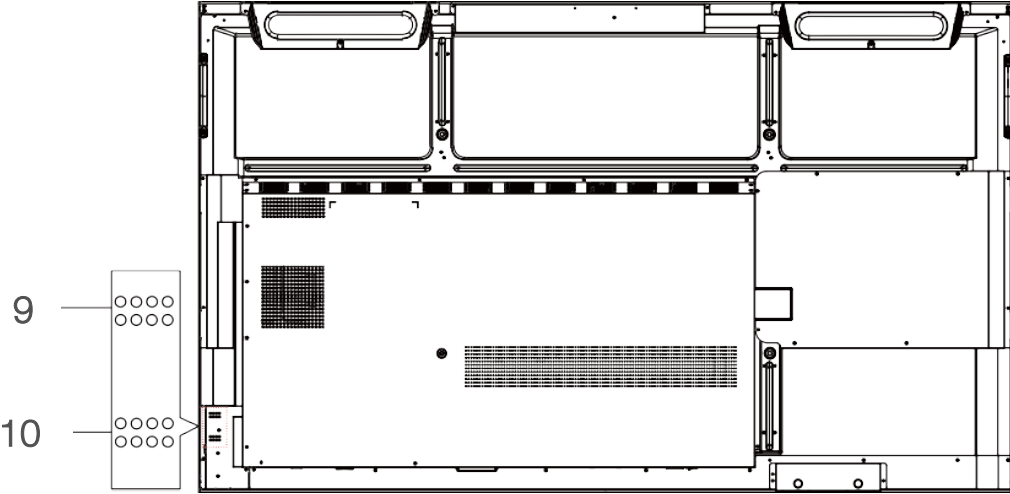
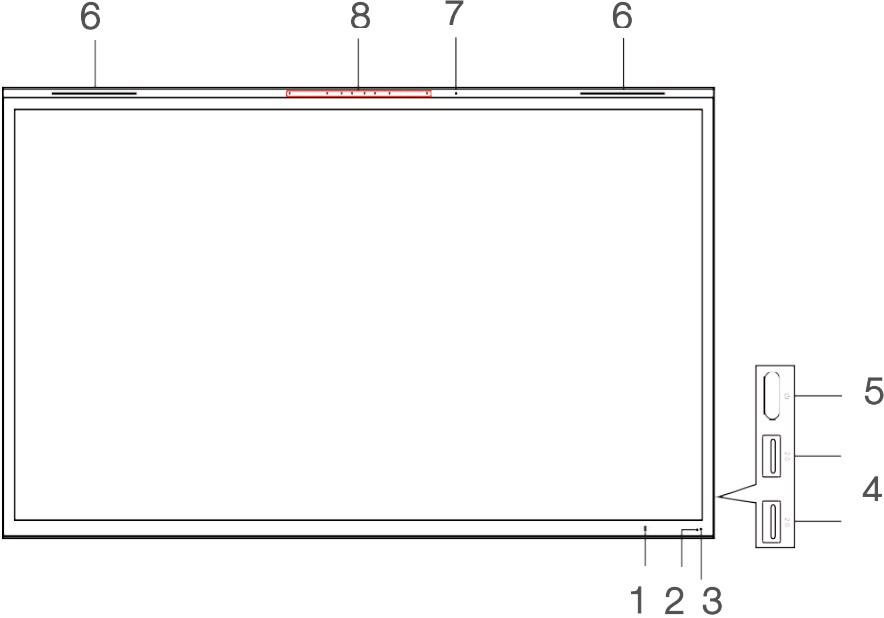

Item Descriptions

1	NFC
2	Remote control signal receiver
3	Power indicator light
4	USB 2.0
5	 : Tap to enter energy-saving, press at least 2 seconds to enter standby mode
6	Loudspeaker
7	Light sensor
8	Microphone
9	Temperature and humidity sensor: Detect the temperature and humidity of the environment.
10	CO2 sensor: Detect the CO2 concentration of the environment.

Terminal Interface

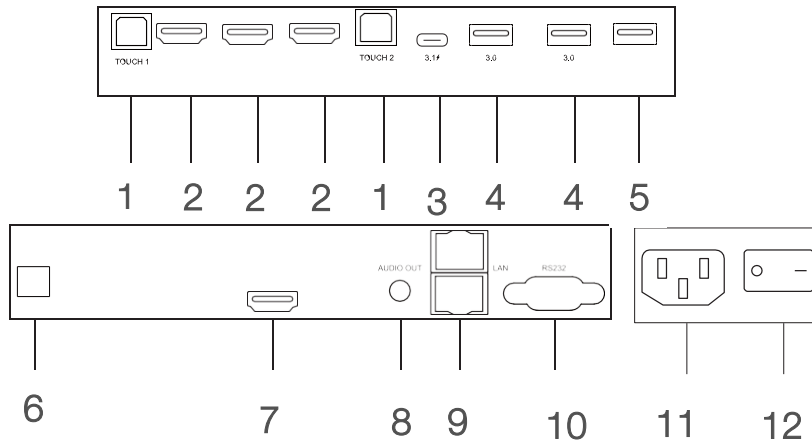

Item Descriptions



1	TOUCH	Touch signal output to the external computer.
2	HDMI	High-definition multimedia interface signal input, connect to devices with HDMI output interface (personal computer with HDMI output, set-top box, or another video device).
3	3.1	Support charging, data transmission, extension for audio and video output interface, etc. <i>Note: The maximum rated power of the USB Type-C port of this product is 65W. When using this port to charge electronic devices, the charging power of the electronic device cannot exceed the rated power of this port. If the charging power of the electronic device exceeds the rated charging power of this port, please Do not directly use this port for charging.</i>
4	3.0	Connect USB devices such as mobile hard disk, U disk, USB keyboard and mouse, USB drives, etc.

5	2.0	Connect USB devices such as mobile hard disk, U disk, USB keyboard and mouse, USB drives, etc.
6	SPDIF	Carry multichannel sound via optical signals.
7	HDMI OUT	Connect to the devices with HDMI input function.
8	AUDIO OUT	Audio output to the external speaker.
9	LAN	Connect RJ45 terminals.
10	RS232	Serial interface, used for mutual transfer of data between devices.
11	AC IN	AC power input, connect AC power supply.
12	AC SWITCH	To open or shut down AC power supply. “I” means power on, “O” means power off.

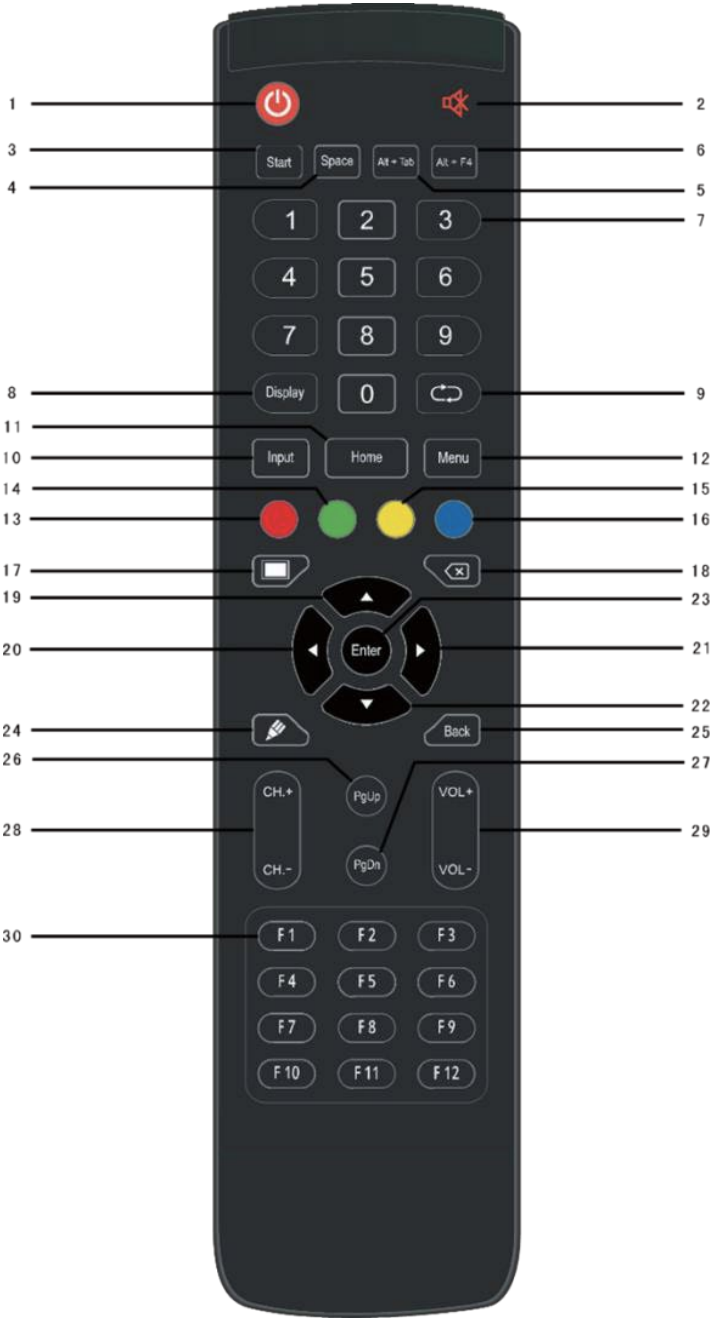





Remote Control



To learn more, visit boxlight.com or call [866.972.1549](tel:866.972.1549).

Item Descriptions		
1		Power on/off
2		Enter or exit mute mode
3	Start	PC's Windows key
4	Space	PC's Space key
5	Alt+Tab	PC's Alt+Tab key
6	Alt+F4	PC's Alt+F4 key
7	Numeric keys	Numeric input
8	Display	Display channel information
9		/
10	Input	Pop up settings menu
11	Home	Return to Android system main screen
12	Menu	Pop up menu

Item Descriptions Continued

13	Red	Enable or disable keys and Touch
14	Green	Enable or disable keys
15	Yellow	Enable or disable Touch
16	Blue	Pop out or close the screen freezing tools
17		Turn off or turn on the screen backlight
18		PC's Backspace
19		Scroll Up
20		Scroll Left
21		Scroll Right
22		Scroll Down
23	Enter	Confirm selection state
24		Quickly start writing software

Item Descriptions Continued		
25	Back	Return to the last operating interface
26	PgUp	Page Up
27	PgDn	Page Down
28	CH./CH.-	/
29	VOL+/VOL-	Increase/reduce the volume
30	F1-F12	PC's F1 - F12 function keys

NOTE: All computer - related function keys are not available without a built-in computer.

Remote Control Instructions

Install Batteries

1. Open the back cover of battery component on the back of remote control.
2. Install AAA type battery according to the corresponding electrode, make sure battery positive and negative pole are correct ("+"to"+", "-" to "-"), please do not mix using old and new batteries.
3. After battery is installed, close the back cover of battery components, and buckle the clip to the bottom.

Range of Remote Control

Remote control can work normally within the range of 8 meters distance, 30 degrees left and right from the remote-control receiver; to protect environment, please dispose waste battery into recycling box.



If battery is replaced by an incorrect type, it may lead to explosion.

Connections and Setting



For the safety of you and the machine, please do not connect any power before connection.

External Computer and Touch Device

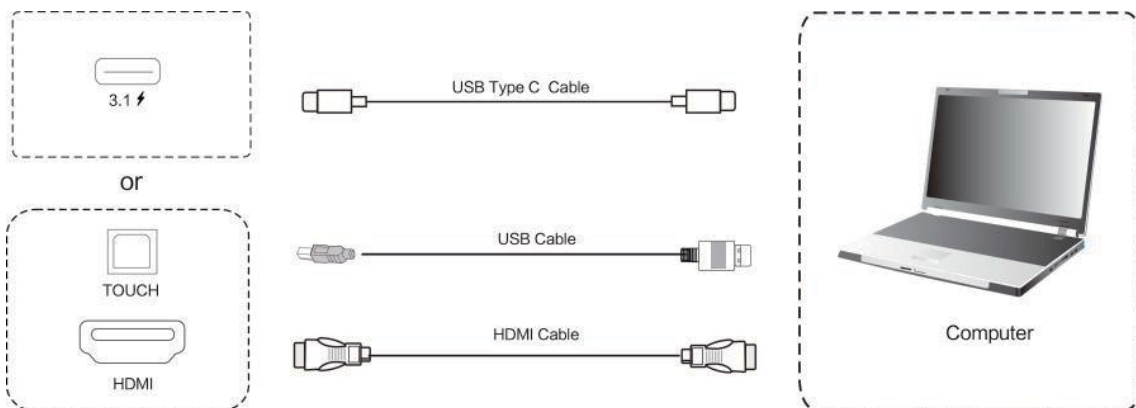

1. USB Type-C cable to connect the computer or use HDMI cable to connect to HDMI output port of external computer and use USB cable to connect to external computer USB port) .
2. After cable connection, plug in the power cord, and switch power on.
3. Start external computer.
4. Press **⏻** key, and the equipment is power on.
5. Switch the input source to the USB Type-C/HDMI channel in the main menu.

Connect to DVD Player

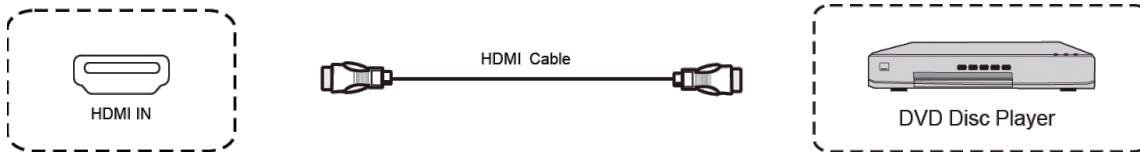

1. Use HDMI cable to connect audio and video equipment with HDMI output.
2. After cable connection, plug in the power cord, and switch power on.
3. Press **⏻** to turn equipment on.
4. Switch the input source to the HDMI channel in the main menu.

USB Connection

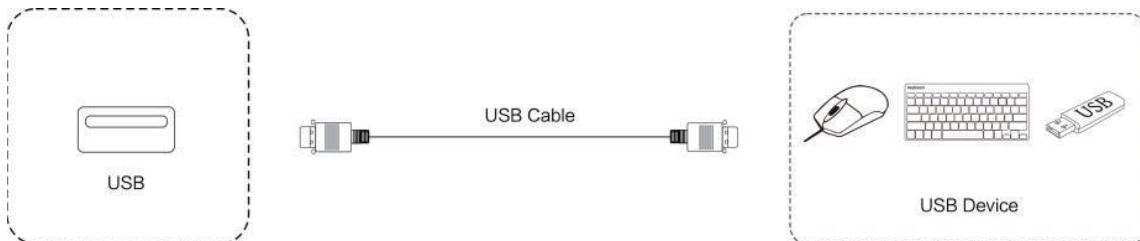

To learn more, visit boxlight.com or call [866.972.1549](tel:866.972.1549).

Connect to Projector

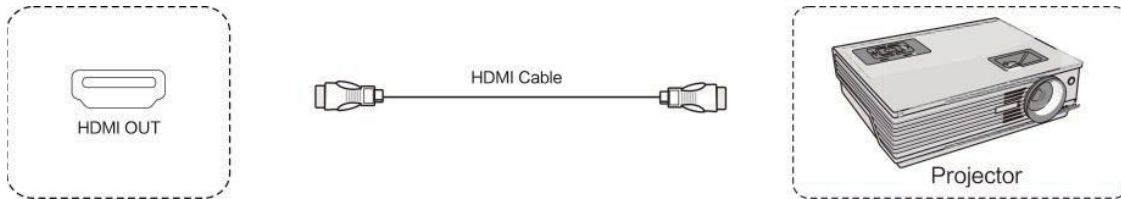

1. Use HDMI cable to connect audio and video equipment with HDMI input.
2. After cable connection, plug in the power cord, and switch power on.
3. Press  to turn equipment on.

Audio Out

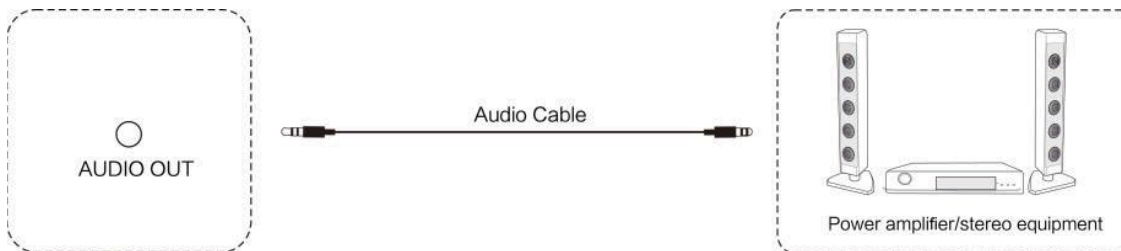

LAN Connection

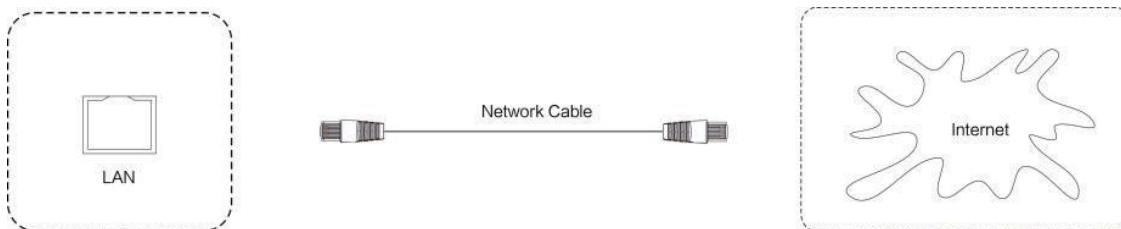

RS232 Connection

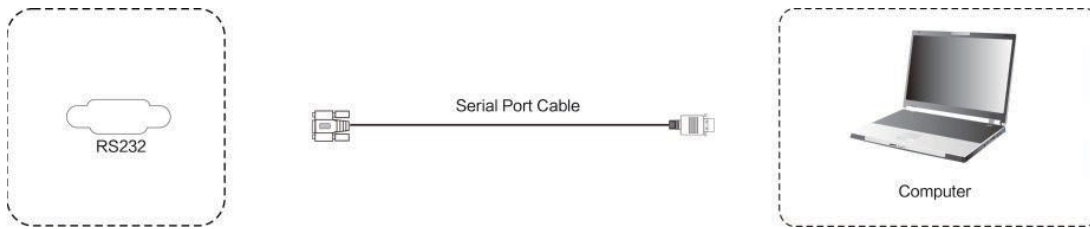

Troubleshooting

Remote Control Failure	
1	Check whether there are other objects between remote control and equipment control receiving window, thus leading to failure of remote control.
2	Check whether the battery electrode in the remote control is correct.
3	Check whether remote control needs to replace battery.

Machine Automatically Shuts Down	
1	Check whether it's set to sleep.
2	Check whether there is a sudden power outage.
3	The system will automatically shut down if the interactive intelligent Panel's external channel loses signal for 5 minutes. Please check the input and connection of the signal.

Display

Signal out of Range	
1	Check whether display is set correctly.
2	Check whether resolution is the best resolution.
3	Adjust line and field synchronization in menu.

Background has Vertical Lines or Streaks	
1	Select automatic correction in menu.
2	Adjust clock and phase position in menu.

Image lack of Color, Color is Incorrect	
1	Check whether VGA is not well connected or has quality problem.
2	Adjust chromatic and brightness or contrast in menu.

Display Format is Not Supported

1	Select automatic correction in menu.
2	Adjust clock and phase position in menu.

Touch Function

Touch Function is Invalid

1	Check whether the size of article touched is comparable with finger.
---	--

Touch Positioning is Incorrect

1	Check whether touch pen is facing the screen.
---	---

Video Function

No Picture and No Sound	
1	Check whether the machine is started state.
2	Check whether signal wire is well plugged, whether INPUT is corresponding to it.
3	If in internal computer mode, check whether internal computer is started.

Horizontal, Vertical Stripes, or Image Dithering	
1	Check whether signal wire is well connected.
2	Check whether other electronic equipment or power tools are placed around the machine.

No Color, Color is Weak or Image is Weak	
1	Adjust chromatic and brightness or contrast in menu.
2	Check whether signal wire is well connected.

Audio Function

Image Displays but Without Sound	
1	Check whether mute button is pressed for mute.
2	Press VOL + / - to adjust volume.
3	Check whether audio line is connected correctly.

Only One Speaker Has Sound	
1	Adjust sound balance in menu.
2	Check whether computer sound control panel only sets up one sound channel.
3	Check whether audio line is connected correctly.

HDMI Output Without Sound	
1	Check whether connect external device.

Maintenance

Proper maintenance can avoid many early faults and regular careful cleaning can make machines appear brand new.

Please unplug the power plug before cleaning and maintenance, to prevent electric shock.

Clean Screen

1. Please mix and stir even a little fabric softener or tableware detergent with alcohol.
2. Please use a soft cloth completely soaked in the mixture.
3. Please take out cloth and twist it to half dry state to wipe machine screen.
4. Repeat several times, pay attention not to squeeze water flow into machine when wiping machine.

Clean Frame

Please use dry, soft, lint-free cloth to wipe the front frame.

Recommendation for Extended Breaks

In case of no use of machine for a long time, such as holiday, please make sure to unplug the plug to prevent any possible dangers caused by power supply ripple from lightning.