

RoboPrint User Guide

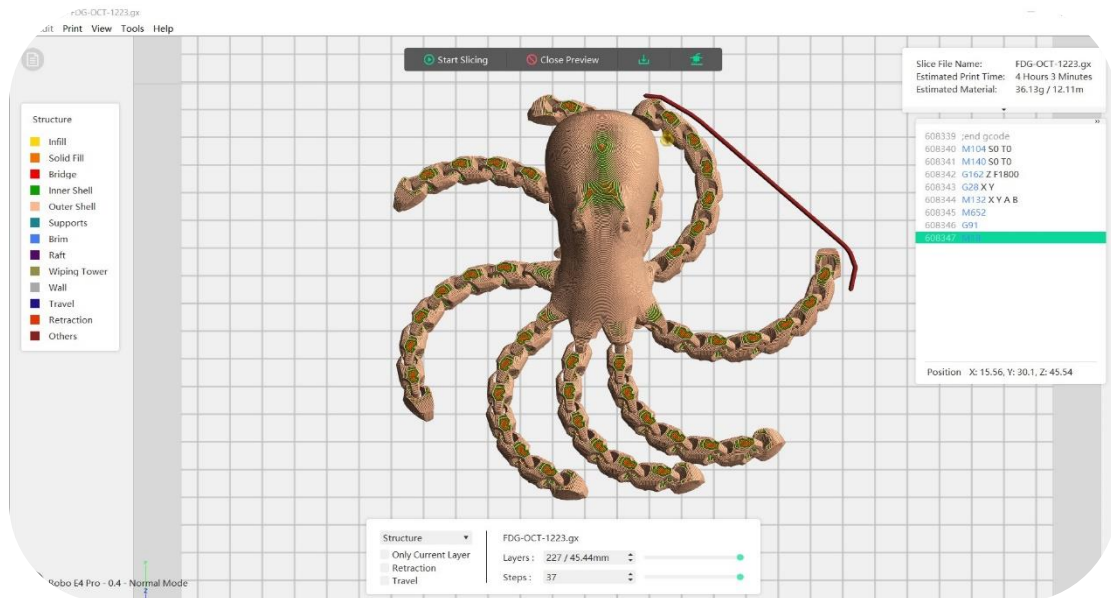

In order to 3D print a model on your Robo printer, you must first run it through a *slicing software* such as RoboPrint or RoboCloud (our online version) so that the printer knows how to read the file. This guide will walk you through how to do so in RoboPrint 5.

Updated February 2024



Updates to the software may have occurred since the creation of this document. Variations may occur between models of 3D printers with what shows in the program.

Contents

Contents	1
1. Software Introduction.....	3
2. Software Installation.....	3
3. Software Operation	3
3.1 Load Files	5
3.1.1 Generate From Image.....	5
3.2 Mouse Action.....	8
3.2.1 Left Click.....	8
3.2.2 Hold Left Mouse Button	9
3.2.3 Right Click.....	9
3.2.4 Hold Right Mouse Button	9
3.2.5 Scroll Mouse Wheel	9
3.3 Scene View Change	9
3.3.1 Drag.....	10
3.3.2 Rotate.....	10
3.3.3 Scale.....	10
3.3.4 Set	10
3.3.5 Reset	10
3.3.6 Model Outline Display.....	10
3.3.7 Steep Surface Display	11
3.4 Edit Models.....	11
3.4.1 Move	11
3.4.2 Rotate.....	12
3.4.3 Scale.....	12
3.4.4 Cut	13
3.4.5 Others	14

3.5 Supports	17
3.5.1 Auto Supports	17
3.5.2 Clear Supports.....	17
3.5.3 Add Supports.....	17
3.5.4 Delete Supports.....	18
3.5.5 Model Option	18
3.5.6 Supports Options	18
3.6 New Project	19
3.7 Save Project	19
3.8 Print	20
3.8.1 Choose Machine Type	20
3.8.2 Connect Machine	20
3.8.3 Print	20
3.9 Printer Operations	38
3.9.1 Connect/Disconnect	38
3.9.2 Control Panel.....	40
3.9.3 Machine Information.....	43
3.9.4 Driver Installation.....	43
3.9.5 Multi-Machine Control	43
3.10 Others	44
3.10.1 Preferences	44
3.10.2 Help Contents.....	45
3.10.3 Feedback.....	45
3.10.4 Check for Updates	45
3.10.5 About RoboPrint.....	46
3.10.6 Model database	46

User Guide

1. Software Introduction

Boxlight's RoboPrint 5 is newly revised and upgraded. Through new interface design and function optimization, the operation is simple and convenient. The slicing file will be prepared by just a few clicks with fast, efficient, and smooth operation.

2. Software Installation

Open the browser and enter <https://robo3d.com/pages/desktop-software>. Download the latest version of RoboPrint 5.

3. Software Operation

Users can control the operation of the printer through the RoboPrint software.

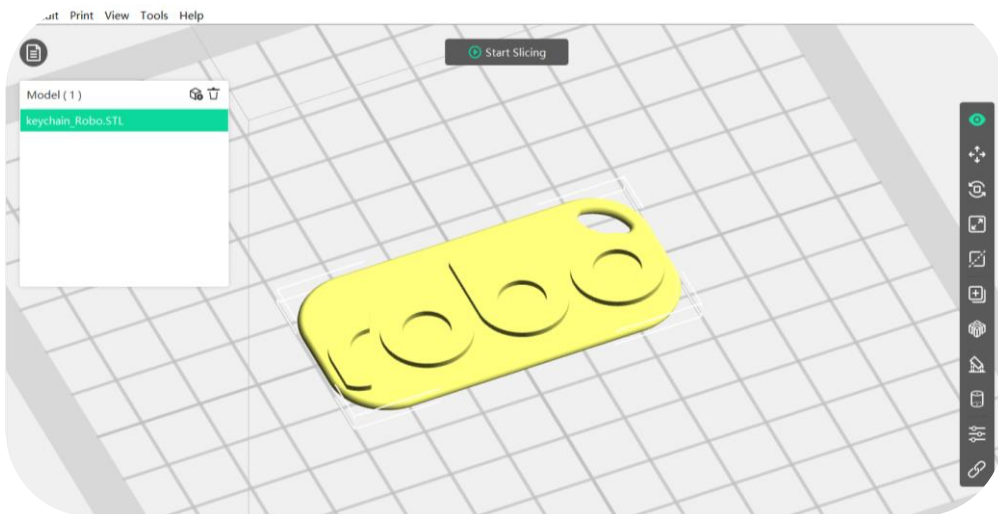

View the model from different angles.



Click it to move the model along X,Y axis, Shift+ mouse click it to move along Z axis.



Rotate the model.



Scale the model size.



Cut the model from different directions.



Copy the selected model file.



Automatically arrange all models.



Enter the support editing mode.



Enter the wiping tower editing mode.



Enter the multi-machine control interface (only compatible with certain models).



Enter the machine connection interface.



Enter the model file list, where you can display, load and delete the model file.



Select the machine type, nozzle size and printing mode.



Enter the slicing parameter editing interface.

3.1 Load Files

Users can load files into RoboPrint in the following ways.

- ◆ Method 1: Click the "Load" icon in the "Model File" list and select the file to be loaded after a dialog box pops up;
- ◆ Method 2: Click "File->Load File" in the menu bar and select the file to be loaded after a dialog box pops up;
- ◆ Method 3: Drag the file to be loaded to the main interface of the software;
- ◆ Method 4: Click the "File-> Examples" in the menu bar to load the files in the list;
- ◆ Method 5: Click the "File-> Recent Files" in the menu bar to load the files opened in the latest period of time in the file list;
- ◆ Method 6: Drag the file to be loaded onto the software icon.

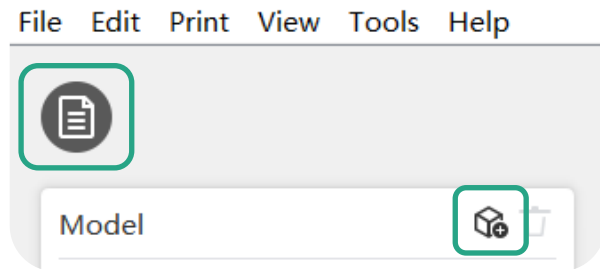

The software currently supports slc, stl, obj, fpp, png, jpg, jpeg, bmp, 3mf format files that can be edited in the software. After loading the model file, if you need to edit the model, you can refer to Section 3.1 to 3.5 (these sections provide detailed information on mouse action, scene view change, model editing and saving, etc). After the model adjustment is completed, the user can slice the model into a Gcode file and print it (please refer to Section 3.8 for details).

The Gcode file is a print file of the model and cannot be modified. But it can be directly used for printing after loading (please refer to Section 3.6.1 and Section 3.6.2.2 for details).

3.1.1 Generate From Image

You can generate relief models from the following image formats: png, jpg, jpeg and bmp. That is, convert the png, jpg, jpeg and bmp format files into the stl format files and load them into the software for use.

Load files in the png, jpg, jpeg, bmp format using the same methods listed above. The "Convert image to stl" window will pop up. From this pop up you can adjust the following parameters:

Shape: It includes six shapes: plane, sphere, tube, canister, lamp(shade), and seal.

Mode: It is divided into "Darker is thicker" mode and "Lighter is thicker" mode.

Maximum Thickness: It converts to the Z value corresponding to stl.

Base Thickness: It is the minimum thickness of the bottom of the generated stl and the default value is 0.5mm.

Width: It converts to the X value corresponding to stl.

Depth: It converts to the Y value corresponding to stl.

Back Cover Thickness: It is for the thickness of the back cover of the canister and lampshade.

Top Diameter: It is for the top diameter of the tube, canister and lampshade.

Bottom Diameter: It is for the bottom diameter of the tube, canister and lampshade.

Pattern Thickness: It is the maximum thickness of the seal surface pattern (only applicable to seals).

Equatorial Diameter: It is the spherical equatorial diameter (inner diameter) size.

Allowable Ellipsoid: It includes 'Yes' and 'No' options. Select 'Yes' to generate the corresponding ellipsoid according to the scale of the loaded picture (the diameter of the two poles depends on the scale of the loaded picture); Select 'No' to generate the sphere according to the loaded picture.

Parameter Window:

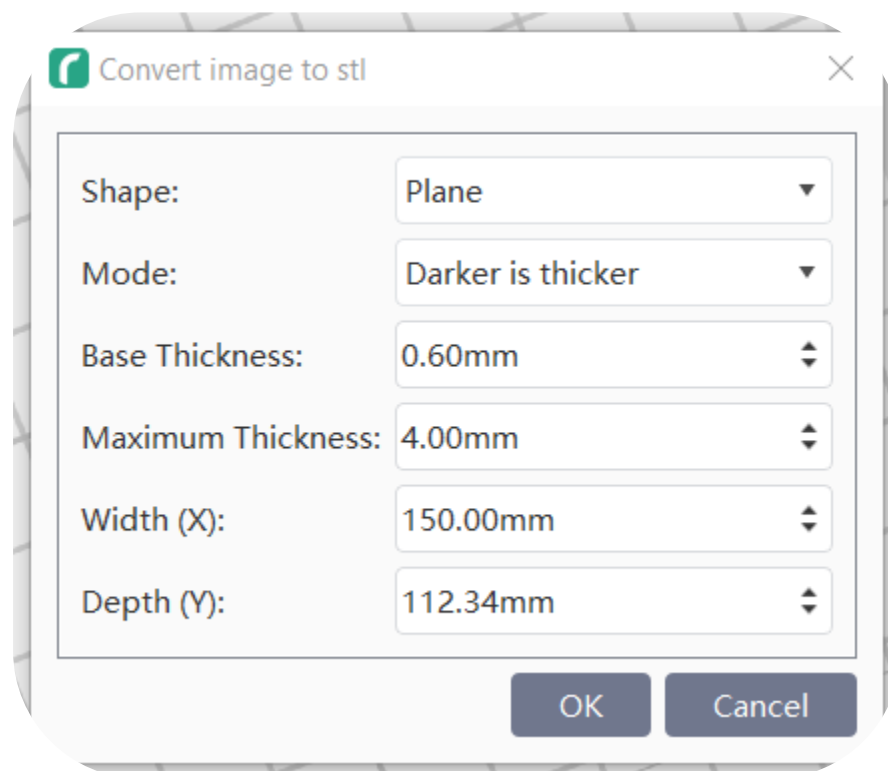

The original png picture is shown to the right. The effects of the converted stl format files after selecting different 'Shape(s)' in the parameter window are pictured below. This process can be used for images like the example but is best for images designed for this, such as black and white displacement maps.

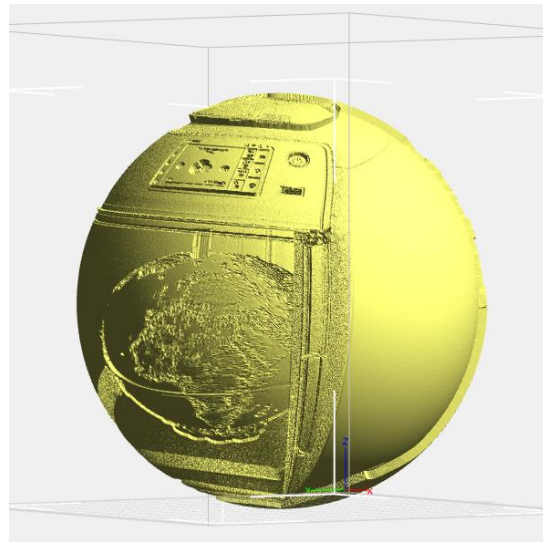
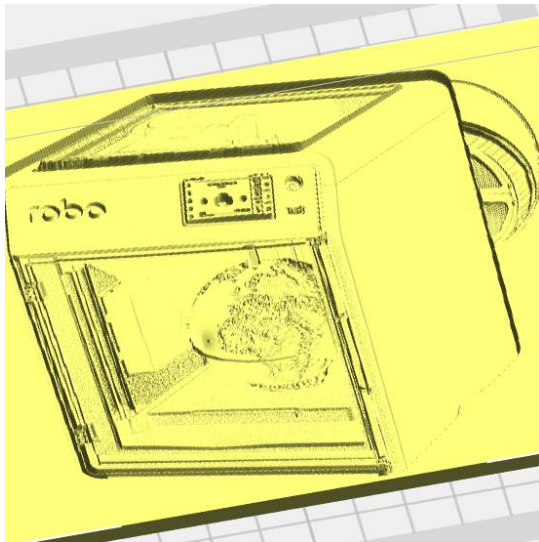

Plane: Generates the image based on darkness. **Sphere:** Translates the image around a sphere.

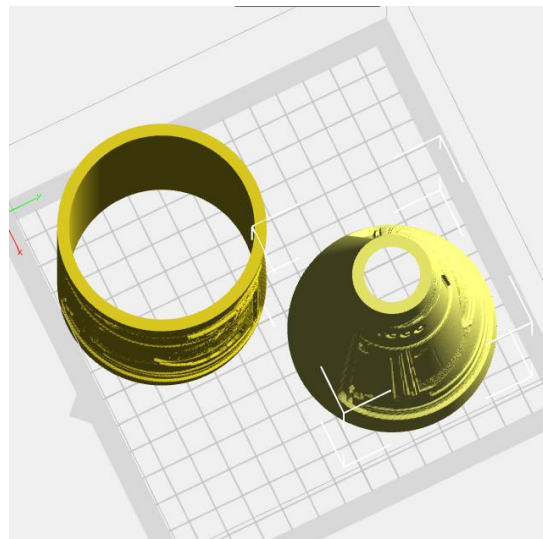
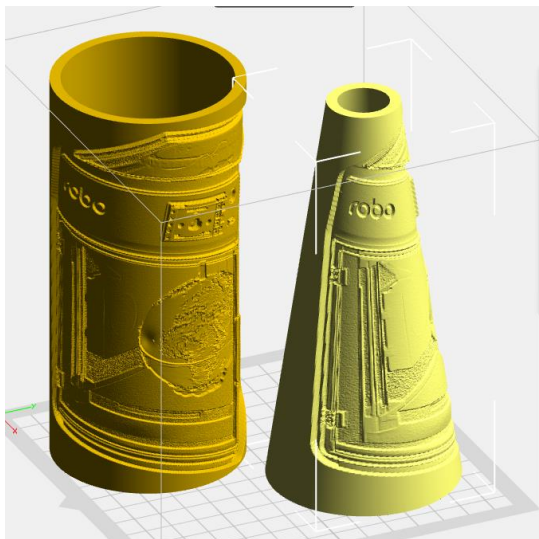

Tube: Translates the image around a tube. The tube is hollow on both ends. Top and bottom diameter can be adjusted as shown here.

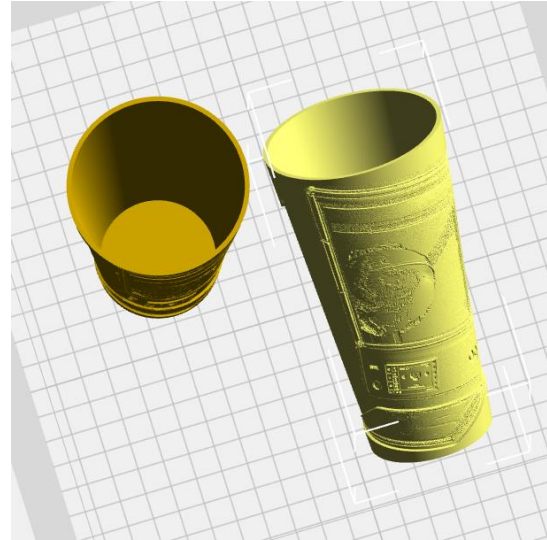
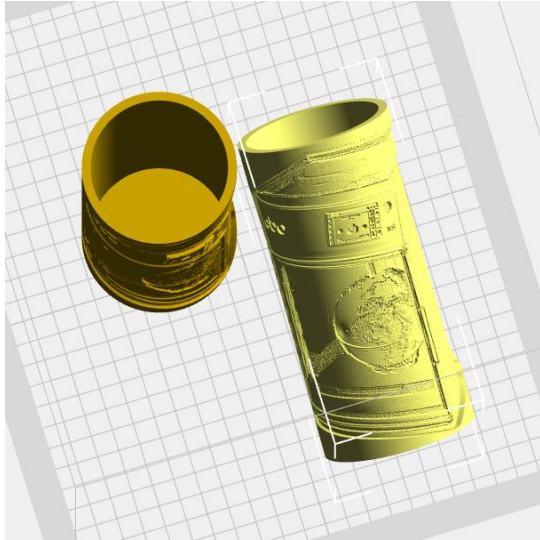

Cannister (left) & Lamp (right): Both cannister and lamp(shade) fill in one side of the image. Cannister fills in the bottom of the tube to make something like a vase. Lamp fills in the top of the tube and then rotates the tube 180° so the filled in edge is on the bottom for better printing.

Both cannister and lamp can be adjusted to taper like we showed with the tube.

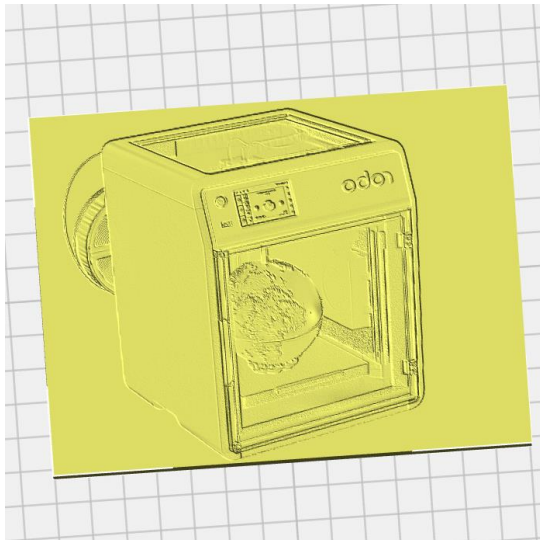

Seal: Creates a mirror image of the provided image so you can stamp it onto another surface.

3.2 Mouse Action

3.2.1 Left Click

- ◆ You can select the current model by left-clicking it.
- ◆ You can select multiple models by holding the Ctrl key and then left-clicking models you want.

- ◆ The selected models will appear in brighter colors.
- ◆ After the models are selected, you can edit the selected models.
- ◆ Click on the blank space to release all the selected models.

3.2.2 Hold Left Mouse Button

When the Ctrl key is pressed, the function of selecting models with the left mouse button is realized. When changing the view or editing the model, the use effect of the left button is different. (please refer to Section 3.3.1 to 3.3.2 and Section 3.4 for details)

3.2.3 Right Click

Right-click will bring up a multi-function menu with the following menu functions:

- ◆ Center Selected Models;
- ◆ Delete Selected Models;
- ◆ Copy Selected Models;
- ◆ Select All Models;
- ◆ Clear Platform(the build plate);
- ◆ Bind(ing) Models;
- ◆ Unbind(ing) Models;
- ◆ Align Models.

3.2.4 Hold Right Mouse Button

In any operating state, the use effect of the right mouse button is the same. (please refer to Section 3.3.1 to 3.3.2 for details)

3.2.5 Scroll Mouse Wheel

In any operating state, the use effect of the mouse wheel is the same. (please refer to Section 3.3.3 for details)

3.3 Scene View Change

You can choose the perspective view or orthogonal view, and you can make changes to the scene view, including dragging the scene, rotating the scene, scaling the scene and so on.

3.3.1 Drag

The model in the print range can be dragged around the screen in the following three ways:

- ◆ Method 1: Long press the left mouse button and drag the mouse;
- ◆ Method 2: Hold the middle mouse button and drag the mouse;
- ◆ Method 3: Hold the Shift key, then long press the right mouse button and drag the mouse.

3.3.2 Rotate

The scene view can be rotated in the following two ways:

- ◆ Method 1: Long press the right mouse button and drag the mouse;
- ◆ Method 2: Hold the Shift key, then long press the left mouse button and drag the mouse.

3.3.3 Scale

In any operating state, you can change the observation distance of the model by scrolling the mouse wheel or using the '+/-' shortcut key.

3.3.4 Set

In the following three ways, the model can be observed from six directions: top view, bottom view, front view, back view, left view and right view.

- ◆ Method 1: Click the "View" button in the menu bar, and you can choose to observe the model from six directions;
- ◆ Method 2: Select the "View" button on the right side, and then click the button again, and a view selection box will pop up, from which you can select views in six directions;
- ◆ Method 3: Select the build plate border and double-click it for view switches.

3.3.5 Reset

Click the "View" button in the menu bar and select "Home View".

3.3.6 Model Outline Display

Click the "View->Show Model Outline" in the menu bar, and the model outline will be displayed.

3.3.7 Steep Surface Display

Click the "View->Show Steep Overhang->Enable/Disable" in the menu bar, if the horizontal angle of the model surface is within the steep overhang threshold value, then this part of the surface belongs to the steep overhang surface and the color changes to red. The steep overhang threshold value can be set as required, and the default value is 45 degrees.

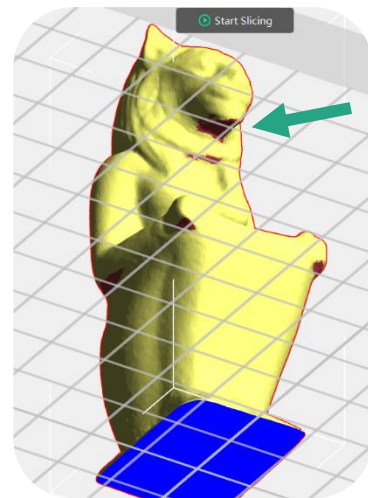
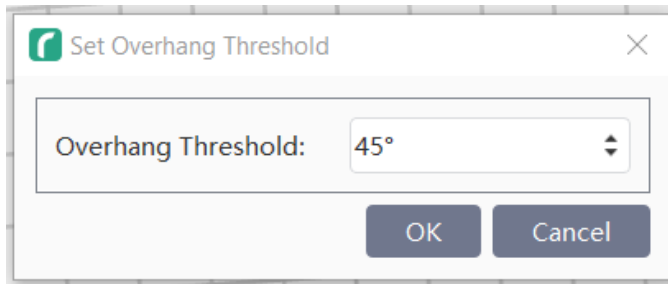

3.4 Edit Models

You can edit the models, including moving, rotating and scaling the models and so on.

3.4.1 Move

After selecting the model to be moved with the left mouse button, the spatial position of the model can be adjusted by the following two movement methods:

- ◆ Method 1: After selecting the "Move" button on the right side, if you press and hold the left mouse button and move the mouse, you can move the model in the XY plane. If you hold the Shift key, press and hold the left mouse button and move the mouse at the same time, you can move the model in the Z direction. In the process of moving, you can see the distance and direction of the movement, which are used to indicate the displacement of the model relative to the previous position.
- ◆ Method 2: Select the "Move" button on the right side, then click it again, a Position Setting box will pop up, where you can adjust or set the position of the model, or reset the model position.

Note: Generally, after the model position adjustment is completed, you need to click the "Center" and "On Platform" buttons to ensure that the model is within the print range and close to the build plate. If you need to arrange the printing position of the model specially, you can just click the "On Platform" button.

To make sure your model is on the build plate, look from below it. Any surface area touching the build plate will show up in blue.

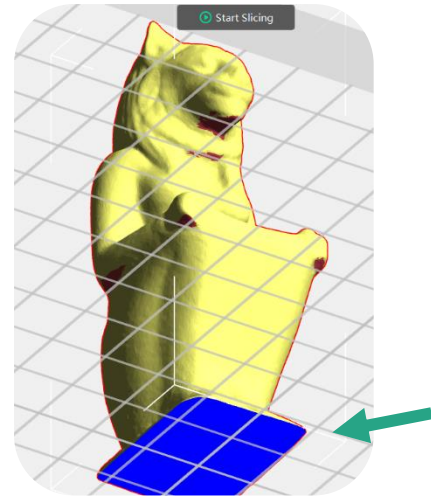

3.4.2 Rotate

3.4.2.1 Select the model to be rotated with the left mouse button, and adjust the placement posture of the model by the following rotation methods:

- ◆ Method 1: After selecting the "Rotate" button on the right side, you will see three rings perpendicular to each other, which are red, green and blue. Click the selected ring to rotate around the current rotation axis (X, Y or Z direction optional). The turning angle and direction of rotation will be displayed at the center of the circle in the form of included angle.
- ◆ Method 2: Select the "Rotate" button on the right side, then a Rotation Setting box will pop up, where you can adjust or set the rotation angle of the model, or reset the model posture.

3.4.2.2 Surface to Platform

After selecting the model, please operate as below:

- ◆ Select "Rotate->Surface to Platform";
- ◆ Select a certain surface of the model with the mouse, double-click the left mouse button on the suspended surface, and the model will be automatically placed according to the surface. Double-check that it lines up well by looking for the blue on the bottom.

3.4.3 Scale

After selecting the model to be scaled with the left mouse button, the size of the model can be adjusted by the following scaling methods:

- ◆ Method 1: After selecting the "Scale" button on the right side, press and hold the left mouse button and drag the mouse to change the model size.

- ◆ Method 2: Select the "Scale" button on the right side, and then click the button again, and a Model Size Setting box will pop up, where you can set the size of the model or change the scale in each direction for scaling.

In addition, if the "Uniform Scaling" option below is checked, changing the length of any side will make the model scale equally; If the "Uniform Scaling" option is unchecked, the length will be changed in a single direction.

3.4.4 Cut

After selecting the model with the left mouse button, select the "Cut" button on the right side and a Cutting Setting box will pop up (as shown below). Cutting settings are: cutting direction (hand-drawing, X plane, Y plane, Z plane), cutting position and "Keep parts in place".

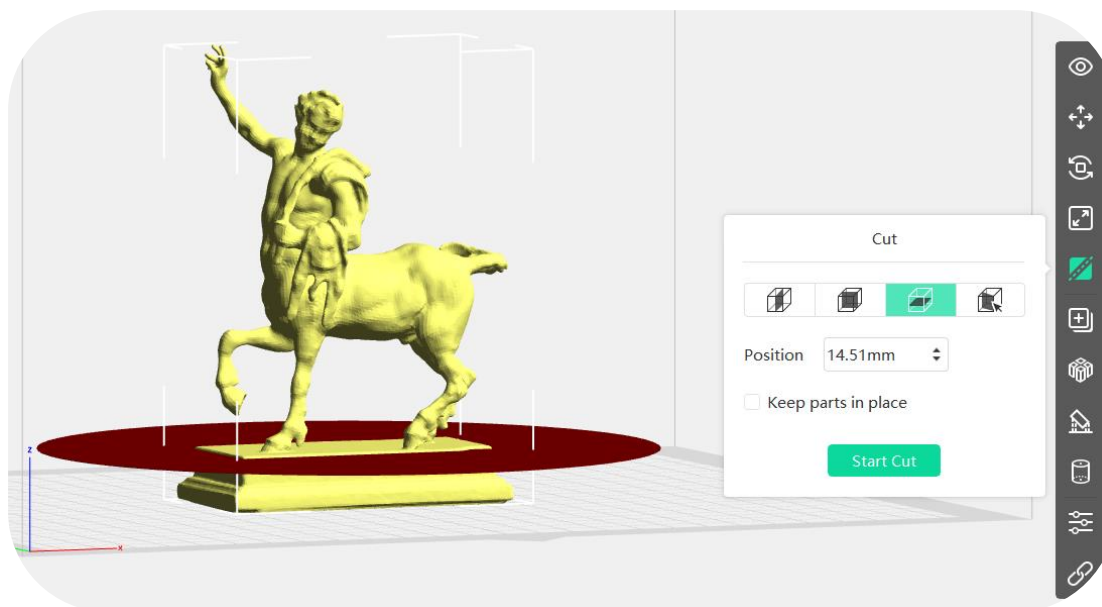

Move the plane around until it is in the correct position and click the "Start Cut" button or double-click the model to cut the model.

Keep parts in place: After cutting, the newly generated model remains in its original position and will not be moved away automatically. The version on the left below shows this option.

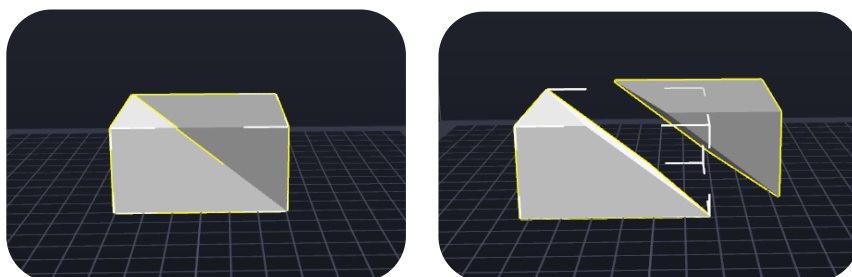

3.4.5 Others

3.4.5.1 Undo

The previous edit to the model can be undone in the following two ways:

- ◆ Method 1: Click the "Edit->Undo" in the menu bar;
- ◆ Method 2: Use the shortcut key Ctrl+Z.

3.4.5.2 Redo

The previous edit to the model can be redone in the following two ways:

- ◆ Method 1: Click the "Edit->Redo" in the menu bar;
- ◆ Method 2: Use the shortcut key Ctrl+Y.

3.4.5.3 Empty Undo-Stack

Clear the recorded operation steps in the undo stack and release the occupied memory.

3.4.5.4 Select All

All models can be selected in the following three ways. (If the models are too small or out of view, you can select all models in the scene and then use the "Center" and "Scale" functions to adjust the models.)

- ◆ Method 1: Click the "Edit->Select All" in the menu bar;
- ◆ Method 2: Use the shortcut key Ctrl+A;
- ◆ Method 3: Click the right mouse button and select "Select All Models".

3.4.5.5 Duplicate

After the model is selected, you can create a copy of the corresponding model in the following three ways:

- ◆ Method 1: Click the "Edit->Duplicate" in the menu bar;
- ◆ Method 2: Use the shortcut keys Ctrl+C and Ctrl+V;
- ◆ Method 3: Click the right mouse button and select "Copy Selected Models".

3.4.5.6 Delete

After the model is selected, you can delete the corresponding model in the following two ways:

- ◆ Method 1: Click the "Edit->Delete" in the menu bar;
- ◆ Method 2: Use the shortcut key Del;

3.4.5.7 Auto Placement

After loading one or more models, click the "Auto Layout All" button on the right side and fill in the "Space Between Models" (range: 0-50mm).

All models will be automatically placed according to the automatic placement rules.

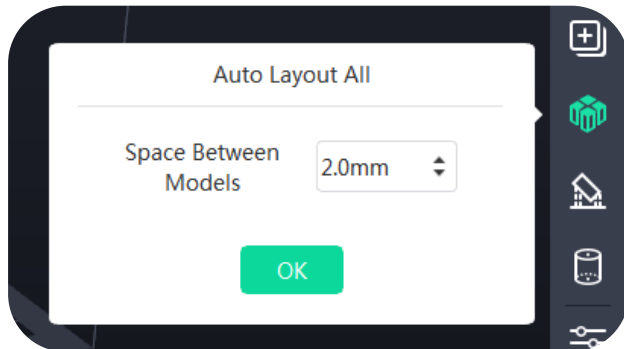

3.4.5.8 Mirror

Click the "Edit->Mirror Models" to perform mirror operation to the selected models in the X-direction, Y-direction and Z-direction.

3.4.5.9 Repair

When a model is loaded, the model will be tested. When the model is detected with problems, a detection prompt will pop up to remind the user; At this time, you can directly click the "Repair Models" button in the pop-up dialog box or select the model and choose "Repair Models" in the "Edit" menu bar to repair the model.

Models that come in with errors will have a red outline.

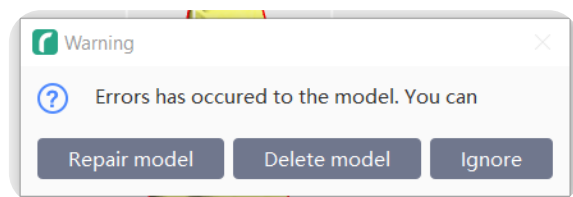
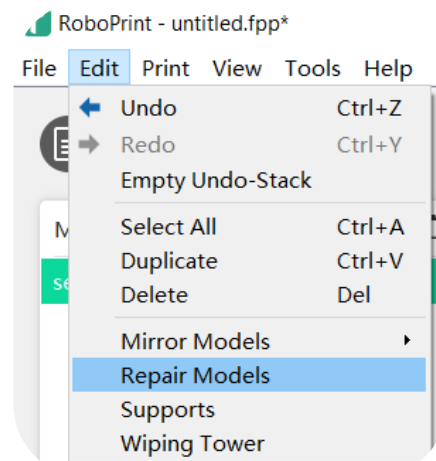





3.4.6.10 Wiping Tower

After loading the model, click the "Edit->Wiping Tower" or click the "Wiping Tower" button on the right side to enter the wiping tower editing interface.

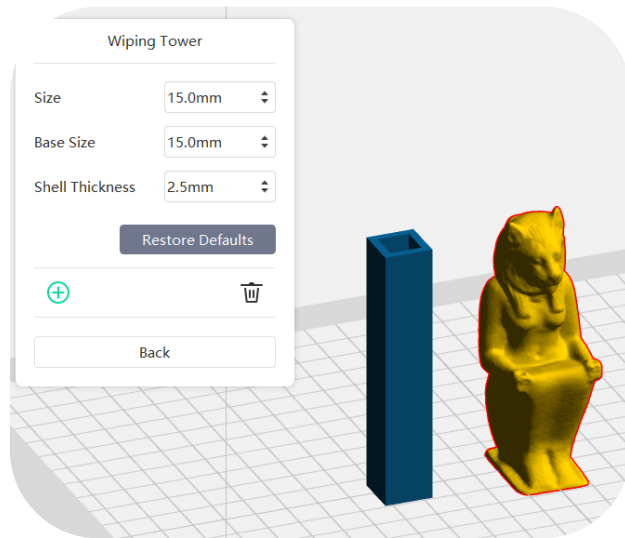
A wiping tower is a method to ensure cleaner transitions between colors of models if you plan to manually change colors partway through a print. If you are not doing so, you may skip adding a wiping tower.

The size, base size and shell thickness parameters of the wiping tower can be set in the wiping tower option setting. The wiping tower height can be set to be the same height as that of the loaded model by default; If there are multiple models, the height of the highest model is taken as the default.



After setting the parameters of the wiping tower, click the "  or   " button, move the mouse to select the coordinates of the wiping tower, and click the left mouse button to add the wiping tower.

When you need to delete the wiping tower, click "  " and select the wiping tower with the left mouse button to delete it.

3.5 Supports

After loading the model, click the "Edit->Supports" in the menu bar or directly click the  button on the right side to enter the support editing mode (as shown below). Click the "Back" button to exit the support editing mode after the support editing is finished.

3.5.1 Auto Supports

After clicking the "Auto Supports" button, the software will automatically determine where the model needs to be supported and generate the corresponding tree-like or linear supports.

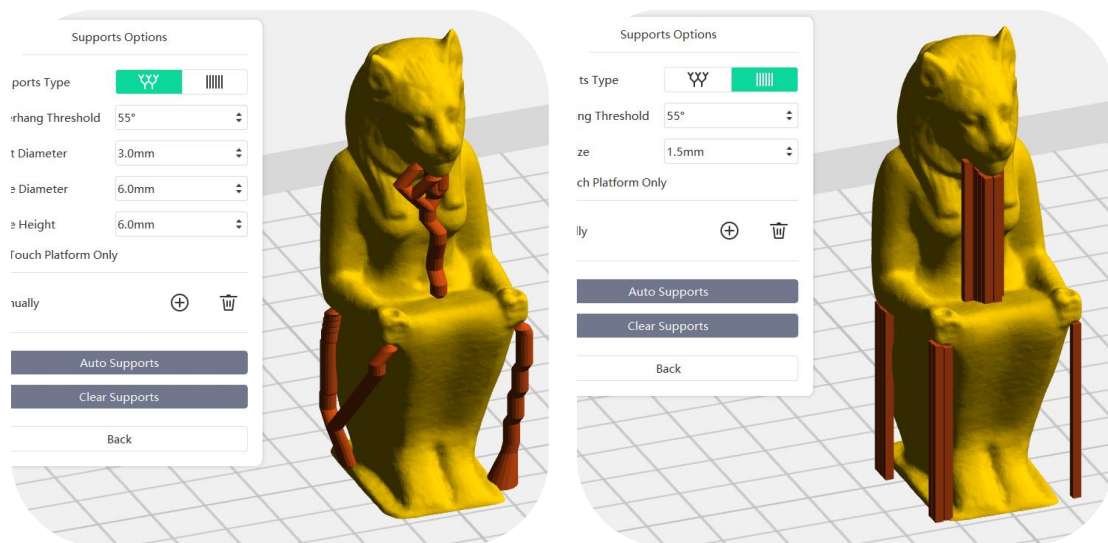

You can adjust the Overhang Threshold higher or lower to add more or fewer supports automatically. You can also manually add and remove supports in this mode. See section 3.5.3 and 3.5.4 below. For additional settings adjustments, see section 3.5.6.

3.5.2 Clear Supports

After clicking the "Clear Supports" button, all supports in the scene will be deleted. Click "Undo" in the menu bar or use the shortcut key Ctrl+Z to undo the operation.

3.5.3 Add Supports

When the "Add" button on the left side is selected, you can add supports. Move the mouse to the position where the model needs to be supported, and click the left mouse button to select the starting point of the support; Hold the left mouse button and drag the mouse to display the support preview (if the support surface does not need support or the angle of the support column is too large, the support preview will be highlighted); Release the left mouse button, and if the support column does not touch the model, the support will be generated at the starting and ending positions (the previewed support will be highlighted, but the support structure will not be generated).

Select "Show Model Slice Outline" in the "View" menu bar, and when the mouse pointer moves to the model, the corresponding model section outline will be displayed at the mouse position for better observation and selection of the supporting point position.

For single selection, please click the mouse.

Hold the "Ctrl" to select more.

Hold the "Ctrl" to drag the box selection.

For Mac version, please hold the "Command" key and drag the mouse to select support.



3.5.4 Delete Supports

When the "Remove" button on the left side is selected, the support can be deleted. Move the mouse to the support to be deleted, and the current support and its child node supports will be highlighted. Click the left mouse button to delete these highlighted supports. Ctrl+left mouse button can check the support to be deleted.

3.5.5 Model Option

When the "Add" and "Remove" buttons are both unchecked, only the selected model will be performed for the "Auto Supports" and "Clear Supports" operations. When there are multiple models, different support parameters can be selected to support different models.

3.5.6 Supports Options

Support parameters can be edited in the "Supports Options" box. Support types include tree and linear support. When "" is selected, parameter values of the tree support will appear: (Steep) Overhang Threshold (Angle), Post Diameter, Base Diameter, Base Height, and Touch Platform Only. Set the required support parameters according to the model, click the "Auto Supports", and the generated support will be displayed as a tree structure; When "" is selected, parameter values of the linear support (Steep Overhang Threshold Angle, Pillar size, Touch Platform Only) will appear. Set the required support parameters according to the model, click the "Auto Supports", and the generated support will be displayed as a linear structure.

- *Overhang Threshold*: it specifies the model position that needs to be generated with supports according to the angle value (inclination of each part of the model) greater than any specified value, and the angle value ranges from 30 to 60 degrees.

- *Post diameter*: the diameter of the tree support, ranging from 1 to 6 mm; Base height: the height of the supporting base, ranging from 0 to 10 mm.
- *Base diameter*: the diameter of the support base, ranging from 3-10 mm.
- *Pillar size*: the pillar is composed of square columns, and the size refers to the single side length of the square columns, ranging from 1 to 8 mm.
- *Touch platform only*: only the support in contact with the bottom plate is generated.

3.6 New Project

Click the "File->New Project" in the menu bar to create a new blank project. If there are unsaved changes in the original project, then you will be prompted if you need to save the changes. If you click "Yes", the changes will be saved. If you click "No", the changes are discarded. If you click "Cancel" or close the box, the new project will be canceled.

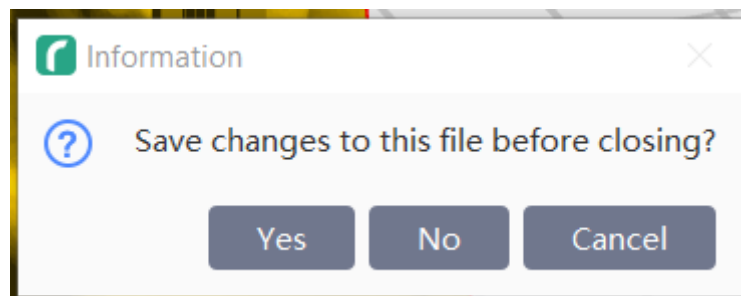

3.7 Save Project

After finishing the editing of the model, all the models in the scene can be saved in the following two ways:

◆ Method 1:

Click the "File->Save Project" in the menu bar to save the file as a project file with the suffix ".fpp". In this type of file, all models (including supports) in the scene are independent. After reloading the file, the support information as well as the model position are the same as the configuration when saving.

◆ Method 2:

Click the "File->Save As" in the menu bar to save the scene as a project file (.fpp) or a file with the suffix ".stl", ".obj" and ".3mf". In the file with the suffix ".stl", ".obj" or ".3mf", the models (including tree supports) in the scene are not independent, but are merged into a new model; The models with linear supports in the scene are independent and the support part will not be saved, but the model part will be saved. After reloading the file, the model is in the same position as that of the saved configuration.

3.8 Print

3.8.1 Choose Machine Type

Before connecting the machine, click the  button at the bottom left corner, and select the current printer type by clicking on the machine name in the "Machine Type" expansion item. After connecting the machine, the software will automatically identify the type of the connected machine, and manual switching cannot be performed at this time. After selecting the machine type, the size of the machine frame in the scene will change, which will also affect the slicing results.

Some Robo printers have multiple nozzle sizes available, and the nozzle size of the printer can be selected in the "Nozzle Size" expansion item.

3.8.2 Connect Machine

In order to connect the printer, we need to configure the printer (please refer to Section 3.9.1.1 for the method).

3.8.3 Print

3.8.3.1 Generate Gcode File by FDM 3D Printer

Before printing the model, the model needs to be sliced (slicing will generate the print file of the model, that is, the Gcode file).

You can configure the slicing parameters and generate the slicing file by the following operations.

- ◆ Step 1: Click the "Start Slicing" icon on the main interface of the software, and a dialog box for setting the slicing parameters will pop up.
- ◆ Step 2: After setting the slicing parameters of the model, click the "Slice" button to start generating the Gcode file, which will be saved in the temporary directory. In this process, a status bar will be displayed at the bottom of the main screen, showing the progress of slicing the model and uploading the Gcode file. After slicing is started, the "Start Slicing" button on the main interface will become the "Stop Slicing" button, which can be clicked to interrupt slicing.
- ◆ Step 3: After finishing slicing, "Slice Preview" and "Local Save" buttons will appear on the top of the main interface. Click the "Slice Preview" button to enter the interface of the slicing preview and observe the slicing results of the model file. Click the "Local Save" button to save the Gcode file locally or send the Gcode file directly to the printer for printing.

1) Slicing parameters in the **basic mode**

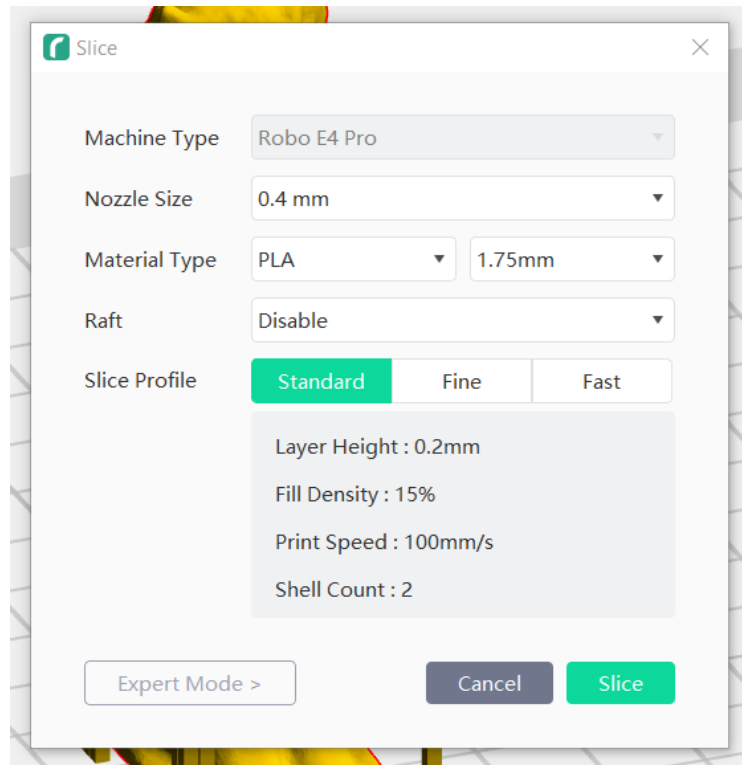

- ◆ **Nozzle Size:** The default nozzle that came with your printer is selected by default. If multiple size nozzles are available for your Robo printer, there will be a dropdown where you can select a different size.
- ◆ **Material Type:** Select the filament you are using and 1.75mm as the appropriate diameter of filament for Robo printers.
- ◆ **Raft:** To improve bed adhesion, *Enable* a raft. This will print an extra couple of layers below your model which can be removed after printing. The purple in the image below is the raft.

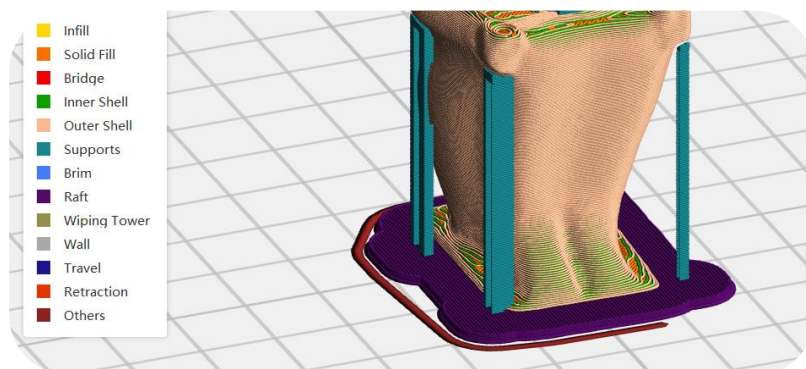

- ◆ **Slice Profile:** Three configuration scheme options (Standard/Fine/Fast) are available in the slicing configuration, and different schemes have been set up with different parameters.

- a. **Layer Height:** It is the printing thickness of each layer when building the model. The smaller the thickness, the smoother the model surface, but the longer the printing time.
- b. **Fill Density:** It is for setting the amount of the internal filling.
- c. **Print Speed:** It is used to calculate the moving speed of the extruder during filament extrusion. The slower the speed, the higher the printing quality, but the longer the printing time.
- d. **Shell Count:** It is the number of paths used to build the model shell. The more paths, the thicker the wall of the model and the longer the print time.

2) Slicing parameters in **expert mode**.

Click the "Expert Mode" button in the basic mode interface to enter the configuration interface of expert mode slicing parameters.

Move the mouse to a slicing parameter or pause on a parameter value text box, and a floating explanation will appear on certain parameters.

◆ **Printer**

- 1) **Nozzle Size:** The default nozzle that came with your printer is selected by default. If multiple size nozzles are available for your Robo printer, there will be a dropdown where you can select a different size.
- 2) **Material Type:** Select the filament you are using and 1.75mm as the appropriate diameter of filament for Robo printers.
- 3) **Slice Profile:** Three configuration scheme options (Standard/Fine/Fast) are available in the slicing configuration, and different schemes have been set up with different parameters.
- 4) **Extruder Temperature:** It is the temperature of the extruder during printing. Check your printer and the filament settings to choose a proper temperature for your machine and the filament you plan on using.
- 5) **Platform Temperature:** Proper platform temperature allows the model to stick to the build plate better and improves the warping problem for larger models.
- 6) **Temperature Control List:** It is for setting the printing temperature for different layers.
- 7) **Control Module:** Select the module of which the temperature needs to be controlled. After adding, select this function, and it will work when printing.

Note: Different temperatures will have a subtle effect on the printing effect. To get better printing results, users may need to make adjustments according to their own conditions.

◆ General

1) **Layer Height:** how thick each layer of the model is. Thicker layers print faster, but have less detail than thinner print layers.

a. Layer Height Mode

1. Fixed Layer Height

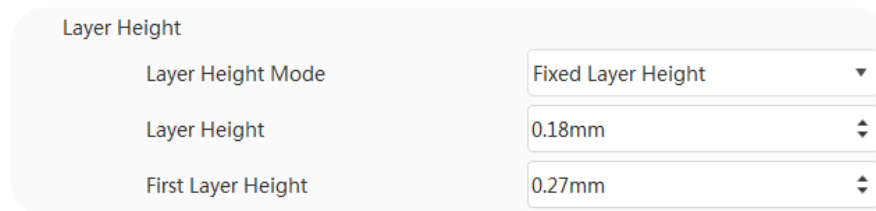

The screenshot shows a settings panel titled "Layer Height". It contains three rows of controls:

Layer Height	
Layer Height Mode	Fixed Layer Height ▼
Layer Height	0.18mm ▲▼
First Layer Height	0.27mm ▲▼

2. Variable Layer Height: Select "Variable Layer Height" and you can enter the variable layer height editing interface.

①  button: Click this button to pop up the variable layer height edit dialog box, where you can add or delete the layer height corresponding to the specified height.

② Model layer height schematic bar: Right-click the slider on the right side of the interface ->  -> The variable layer height edit dialog box pops up. At the same time, the default added height is the height corresponding to the mouse clicking position, and the default deleted height is the closest added height to the mouse clicking position.

③ Click the "OK" button to return to the expert mode interface.

b. *Layer height:* It is the printing thickness of each layer when building the model. The smaller the thickness, the smoother the model surface, but the longer the printing time.

c. *First Layer Height:* When printing with a smaller layer height, the larger first layer height allows the model to stick better to the build plate.

2) Speed

a. *Base Print Speed:* It is the reference movement speed of the extruder during filament extrusion, taken as the reference value for the subsequent printing speed calculation.

- b. *Travel Speed*: It is the movement speed of the extruder when there is no filament extrusion.
- c. *Minimum Speed*: It is the minimum movement speed of the extruder during filament extrusion.
- d. *First Layer Maximum Speed*: It is used to limit the printing speed of the first layer to allow the model to better adhere to the build plate. This parameter does not work when the raft function is enabled.
- e. *First Layer Maximum Travel Speed*: It is used to limit the travel speed of the first layer to allow the model to better adhere to the build plate. This parameter does not work when the raft function is enabled.
- f. *Slow Down First Few Layers*: Lower the printing speed of the first few layers to improve the printing success rate; For example, 3, 30mm/s means that the first 2-4 layers are printed at a speed of 30 mm/s; The first layer is not controlled by this command, and this function does not work when it is set to 0.

3) Retraction

- a. *Retraction Length*: It is the length for retracting the filament back to the nozzle before extruder traveling or switching to improve the filament leakage problem.
- b. *Retraction Speed*: The speed at which the extruder retracts the filament back into the nozzle.
- c. *Extrusion Speed*: The speed at which the extruder extrudes the filament out of the nozzle.
- d. *Extra Restart Length*: The compensation length of the extruded filament after retraction.

Retraction	
Retraction Length	5.0mm
Retract Speed	25mm/s
Extrude Speed	25mm/s
Extra Restart Length	0.0mm
Only Retract When Crossing Outline	Yes

- e. *Only Retract When Crossing Outline*: It is used to reduce the number of times of retraction, but it is easy to leave filaments at the peak. Select "No" to avoid this problem. This function is only supported by the Robo E3 at the moment.

◆ Shells

1) Thickness

- a. *Shell Count*: It is the number of paths used to build the model shell. The more paths, the thicker the wall of the model.
- b. *Shell Thickness*: The thickness of the shell of the model.
- c. *Overlap Perimeter*: The maximum width ratio of shell path overlapping allowed at thin wall.

2) Speed

- a. *Exterior Speed*: The ratio of the printing speed of the outermost layer of the model shell relative to the reference speed.
- b. *Exterior Maximum Speed*: It is used to limit the printing speed of the outermost layer of the model shell.
- c. *Visible Interior Speed*: The ratio of the printing speed of the visible part of the inner layer of the model shell relative to the reference speed.
- d. *Visible Interior Max Speed*: The maximum printing speed of the visible inner ring.
- e. *Invisible Interior Speed*: The ratio of the printing speed of the invisible part of the inner layer of the model shell relative to the reference speed.

3) Start Points

- a. *Mode*: It is used to set the rules for selecting the start point of the shell path. There are three start point modes: one is "closest to specific location", the other is "use random start points", and the other is "inner recess point".
 - Closest to specific location*: The start points of the shell paths of all layers are as close as possible to the specified coordinates to align the joint position.
 - Use random start points*: The start points of the shell are randomly distributed on the surface of the model to hide the joint position.
 - Inner recess point*: The inward-concave point is preferred as the start point, and the point closest to the specified position is used as the start point when there is no inward-concave point.
- b. *X*: X coordinate of the start point alignment position of the shell.
- c. *Y*: Y coordinate of the start point alignment position of the shell.

d. *Permit optimizing start points*: It allows the software to adjust the start point position as required, using a point other than "the point closest to the specific position" as the start point. It is recommended to select "No" when printing a vertically placed displacement model generated from an image.

◆ Infill

1) General

a. *Top Solid Layers*: The number of layers using solid fill on the upper surface of the model.

b. *Bottom Solid Layers*: The number of layers using solid fill on the lower surface of the model.

c. *Fill Density*: It is used to set the compactness degree of the internal filling.

d. *Fill Pattern*: It is used to set the shape of internal filling.

- Hexagonal filling is with higher strength,
- Linear filling prints faster,
- Triangular filling prints slightly slower than linear filling, but the adhesion between layers is higher.
- Three-dimensional filling is a three-dimensional spiral filling shape, which is generally used when the filling density is low. It is recommended to turn off the "Combine Infill" function when using this filling.

e. *Overlap Perimeter*: The width ratio of the filling to the shell overlap path.

f. *Vase Mode*: It is used to print single-layer models without joints. When this function is enabled, the number of shells is always 1, the filling density is always 0, and the number of top layers is 0 by default.

2) Speed

a. *Solid Speed*: The ratio of the model's top and bottom fill printing speed relative to the reference speed.

b. *Sparse Speed*: The ratio of the printing speed of the internal filling of the model relative to the reference speed.

3) Combine Infill

a. *Maximum Solid Combine*: The filling areas overlapping between adjacent layers are merged to print together to increase the printing speed. After merging, the filling path will become thicker, but the thickness of the shell path

will remain unchanged. It is recommended that the height of the top/bottom cover should not exceed 0.2mm after merging.

b. *Maximum Sparse Combine Layers*: The filling areas overlapping between adjacent layers are merged to print together to increase the printing speed. After merging, the filling path will become thicker, but the thickness of the shell path will remain unchanged. It is recommended that the height of interior filling should not exceed 0.36mm after merging.

c. *Combine Area Threshold*: When the printing area of a certain layer is less than the specified threshold, the layer will not be merged and filled, in order to increase the printing time of the layer and ensure that the next layer can be printed after the filament cools down.

4) Strength(en) Infill

a. *Interval Layers*: Extra solid filling of some layers at each interval of a certain number of layers makes the model more solid, and "0" means it is not enabled.

b. *Solid Layers*: The number of added layers for solid filling.

c. *Infill Density Control*: It is used to add the layer control command of filling, conducive to strength enhancement and rational utilization of materials according to the needs of the model design; It is also used for the filling density layer control. The density items from the Start Layer to the End Layer are specially set.

◆ Supports

1) Supports Type

① Tree:

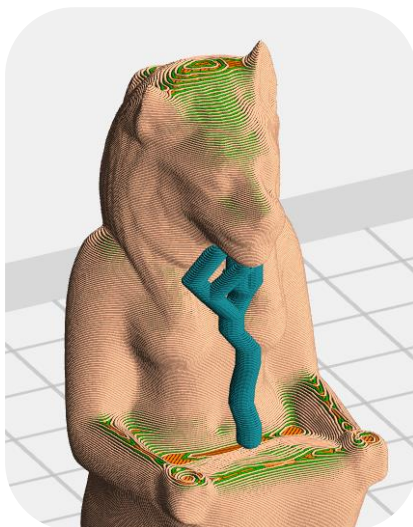

a. *Speed*: The ratio of tree support printing speed relative to the reference speed.

b. *Space to Model (X/Y)*: It is used to set the minimum clearance between the model and the support in the horizontal direction to facilitate the support removal.

c. *Shell Count*: It is the number of paths used to build the tree support shell. The more paths, the thicker the wall of the tree support.

d. *Auto Setup Z Hop*: Raise the extruder or lower the build plate when the extruder is traveling to avoid the tree support being knocked down by the extruder.

② **Linear:**

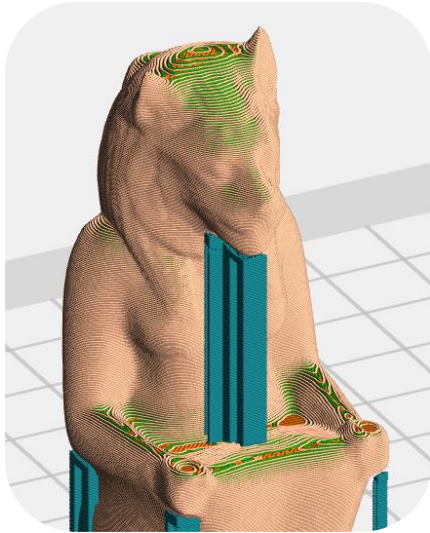

- a. *Speed*: The ratio of linear support printing speed relative to the reference speed.
- b. *Space to Model (X/Y)*: It is used to set the minimum clearance between the model and the support in the horizontal direction to facilitate the support removal.
- c. *Space to Model (Z)*: It is used to set the clearance between the model and the support in the vertical direction to facilitate the support removal.
- d. *Space to Raft (Z)*: It is used to set the clearance between the raft and the support in the vertical direction to facilitate the support removal.

e. *Path Space*: It is used to set the spacing between adjacent round-trip paths of the linear support. Smaller spacing provides better supporting effect, but it takes more printing time and makes removing the supports more challenging.

f. *Path Density*: It is used to set the density of the support path. The higher the density, the more solid the support, but the longer the printing time and the more filament will be used.

g. *Support Thickness*: The higher the thickness of the support, the more solid the support; the lower it is, the easier it is to remove the support.

h. *Top Solid Layers*: The linear support top cover can improve the printing quality of the contact surface between the model and support, but it is not conducive to the support removal.

i. *Path Angle*: The angle between the support path and the filling path of the first layer.

j. *Top Solid Density*: It is used to set the density of the support path top cover. The higher the density, the more solid the support, but it is not conducive to the support removal.

k. *Horizontal Expansion*: Expanding the support area in the horizontal direction can avoid the lack of support at the edge of the model.

l. *Print Outline*: You can choose whether to print the outline of the linear support or not with this parameter option. Select "Yes" can avoid the problem of incomplete support area, and select "No" can facilitate the support removal.

◆ Raft

1) General

- a. *Enable Raft*: Print a raft on the build plate before printing the model so that the model can stick to the build plate better. Select 'Yes' to use the raft and 'No' to not use the raft.

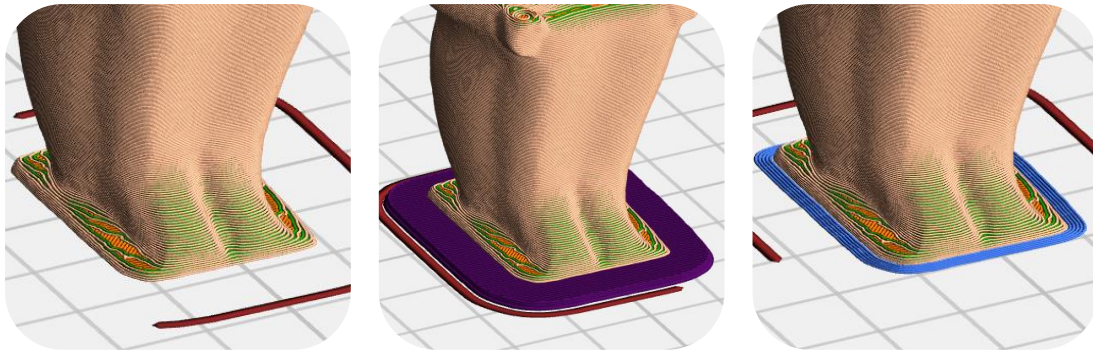

No Raft or Brim

Raft

Brim (See Additions)

- b. *Margin*: The width of the raft extending outward from the first layer outline of the model.
- c. *Space to Model (Z)*: It is used to set the clearance between the model and the raft in the vertical direction to facilitate the raft removal.
- d. *Above Raft Maximum Speed*: Limit the printing speed of the first layer above the raft to make the model stick to the raft better.
- e. *Above Raft Extrusion Ratio*: It is used to set the amount of the filament extrusion of the first layer above the raft. The more the filament extrusion, the better the printing quality of the first layer of the model, and the more difficult it is to remove the raft.

2) Bottom layer

- a. *Layer Height*: The higher bottom layer height makes it easier for the raft to stick to the build plate. When the build plate temperature is higher, the thicker raft features better thermal insulation.
- b. *Path Width*: The wider path width makes it easier for the raft to stick to the build plate, but the wider path requires slower printing speed.
- c. *Fill Density*: The higher the filling density, the more firmly the raft and the build plate stick together, and the longer the printing time.
- d. *Speed*: With higher layer heights and larger path width, use a slower printing speed; otherwise it will not be able to extrude the filament in time.

3) Middle Layers

- a. *Layer Height*: The height of the transition layer in the middle of the raft.
- b. *Layers*: The number of transition layers in the middle of the raft.
- c. *Path Width*: The wider path width makes it easier for the raft to stick to the build plate, but the wider path requires slower printing speed.
- d. *Fill Density*: The higher the filling density, the more firmly the raft and the build plate stick together, and the longer the printing time.
- e. *Speed*: The lower the speed, the better it is for the transition layer and the bottom layer to stick together, and the longer the print time.

4) Top Layers

- a. *Layer Height*: The layer height of the top layer of the raft.
- b. *Layers*: The number of the top layers of the raft. When the temperature of the build plate is more than 110° C, it is recommended to add several layers to increase the thermal insulation of the raft.
- c. *Path Width*: The wider bottom layer path width makes it easier for the raft to stick to the build plate, but the wider path requires slower printing speed.
- d. *Speed*: The lower the speed, the better the smoothness of the top surface of the raft, and the longer the printing time.
- e. *Angle Between Model*: The angle between the filling path of the top layer of the raft and the model.

◆ Additions

1) Pre-extrusion

- a. *Enable Pre-extrusion*: Before starting to print the model, an extra filament extrusion path should be made to ensure smooth filament extrusion of the subsequent model printing.

In the above images, the dark red line is the pre-extrusion.

- b. *Margin*: The spacing from the pre-extrusion path to the first layer outline of the model.
- c. *Path Length*: The length of pre-extruded filament.
- d. *Speed*: The printing speed of the pre-extrusion path.

2) Wall

- a. *Enable Wall*: Generates an additional wall structure all the way around the outside of the model. You will most likely not need to use this feature.
- b. *Shell Count*: It is the number of paths used to build the model shell. The more paths, the thicker the wall of the model, but the longer the printing time.
- c. *Margin*: It is used to set the spacing between the model and the wall.
- d. *Speed*: The wall printing speed.
- e. *Generate Wall inside holes*: If you select "Yes", the walls inside the model holes will be automatically eliminated when the walls are generated; If you select "No", the walls inside the model holes will not be eliminated.

3) Brim

- a. *Enable Brim*: An additional circle of brim is printed around the bottom of the model and the extension part of the bottom of the model is fixed on the build plate to prevent it from overturning during printing.

See "Raft" above for a sample image.
- b. *Margin*: It is the width of the brim. The greater the width, the more solid the brim, but the longer the printing time.
- c. *Brim Layers*: More brim layers can fix the model better, but are not conducive to the brim removal from the model.
- d. *Speed*: The brim printing speed.
- e. *Generate Brim inside holes*: If you select "No", the brim is no longer generated inside the holes, thus avoiding the problem that these brims are difficult to remove.

4) Wiping Tower

- a. *Speed*: The wiping tower printing speed.

◆ Cooling:

1) Decelerate/Delay For Filament Cooling

- a. *Deceleration Area Threshold*: When the printing area of a layer is less than the specified threshold value, the printing speed of that layer is reduced to ensure sufficient filament cooling time.

- b. *Delay Area Threshold*: When the printing area of a layer is less than the specified threshold value, the printer will delay printing after printing the layer to ensure sufficient filament cooling time, and 0 means that the printer will not delay printing for filament cooling.
- c. *Maximum Delay Time*: The maximum delay time for filament cooling.

Decelerate/Delay For Filament Cooling	
Deceleration Area Threshold	50mm ²
Delay Area Threshold	0mm ²
Maximum Delay Time	1.5s

2) Cooling Fan Control

- a. *Cooling Fan Control*: It is used to set when to turn on the cooling fan, including "Always On", "Always Off", "ON (when raft bottom printed)", "ON (when to pre-set height)", "ON (while printing raft top)".
- b. *Back Fan Status*: It is used to set the status of the cooling fan on the back of the printer, including "Always On" and "Always Off".
- c. *Back Fan Speed*: It is used to set the rotating speed of the cooling fan on the back of the printer.

Cooling Fan Control	Always On
Back Fan Status	Always On
Back Fan Speed	100%

- d. *Cooling Fan Default Speed*: It is used to set the original rotating speed of the cooling fan of the printer.
- e. *Cooling Fan Control List*: Change the cooling fan speed after printing to the set height.

Cooling Fan Control	Always On						
Cooling Fan Default Speed	100%						
Cooling Fan Control List	<input checked="" type="checkbox"/> <div style="display: flex; align-items: center; gap: 5px;"> + 🗑️ </div> <table border="1" style="width: 100%; text-align: center;"> <thead> <tr> <th>Start Layer</th> <th>End Layer</th> <th>Speed</th> </tr> </thead> <tbody> <tr> <td> </td> <td> </td> <td> </td> </tr> </tbody> </table>	Start Layer	End Layer	Speed			
Start Layer	End Layer	Speed					

◆ **Advanced**

1) Bridge

- a. *Enable Bridge*: Optimize the direction of the filament extrusion path in the overhanging area and shorten the path span of the filament to improve the printing effect of the overhanging part of the model.
- b. *Bridge Area Threshold*: When the area of the overhanging area is less than the specified threshold value, it is no longer treated as a bridge and the bridge function is not available.
- c. *Speed*: The ratio of the bridge printing speed relative to the reference speed.

Bridge	
Enable Bridge	Yes
Bridge Area Threshold	15mm ²
Speed	80%

2) Extrusion Ratio

- a. *Extrusion Ratio*: It is used to adjust the amount of filament extrusion.
- b. *First Layer Extrusion Ratio*: It is used to adjust the proportional parameter for the filament extrusion of the first layer.

3) Path

- a. *Path Width*: It is the width of the filament extrusion path. The default value is the diameter of the nozzle.
- b. *Path Precision*: When the model features too many mesh subdivisions, it determines the simplification degree of the filament extrusion path. The higher the value, the lower the precision of the filament extrusion path, but the higher the precision of the corresponding filament extrusion amount.

4) Ironing

- a. *Enable Ironing*: After enabled, it will pass through the top surface again, but this time, very little filament is extruded, which means that the plastic on the top will be further melted to form a smoother surface, and the pressure in the nozzle will remain high, to ensure that the surface creases can also be filled with materials to guarantee details.

◆ **Others**

1) Dimensional Adjustments

- a. *Enable Adjustments*: Adjust the printing path for offsetting printing errors.
- b. *External Compensation*: Adjust the size of the outer diameter of the model, with a positive number indicating size enlargement and a negative number indicating size reduction.
- c. *Internal Compensation*: Adjust the size of the inner diameter of the model, with a positive number indicating size enlargement and a negative number indicating size reduction.
- d. *Z Compensation*: Adjust the printing height of the model, with a positive number indicating increase and a negative number indicating decrease.

Dimensional Adjustments	
Enable Adjustments	No
External Compensation	0.00mm
Internal Compensation	0.10mm
Z Compensation	0.00%

2) Z Hop

- a. *Z Hop Mode*: Lift the extruder or lower the build plate when idling to prevent the extruder from hitting the model.
- b. *Z Hop Height*: The extruder-lifted height or the platform-lowered height when idling.
- c. *Z Hop Minimum distance*: When the idling distance is less than the specified value, Z lifting is not carried out.

Z Hop	
Z Hop Mode	Always Disable
Z Hop Height	0.20mm
Z Hop Minimum Distance	1.00mm

3) Pause At Layers

- a. *Pause Layers*: Automatically pause printing after printing to the set height. Edit one or more height values to be paused, and the maximum pause height shall not exceed the model height.

This is very useful when printing multi-color prints!

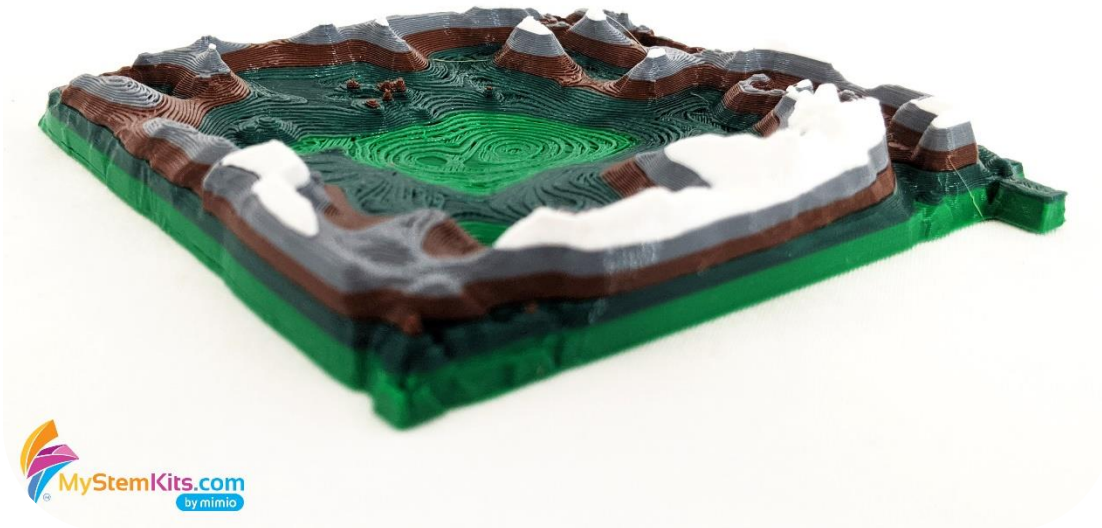

◆ Save As New

After modifying the required parameters according to the user's requirements, it can be saved as a new preset for subsequent use.

Modify the required parameters, click the "Save As New" button, and a name input box pops up. Fill in the name according to your needs, and click the "OK" button to save the settings successfully.

After doing so, in the 'Printer->Slice Configuration' list, there will be one more optional setting (the newly added pre-set is related to the currently selected machine type and will only show up when that printer is selected)

◆ Remove

The "Remove" function is only available for the presets newly added to the current machine type. Select a new scheme, click the "Remove" button and a prompt box for confirmation of deletion pops up. Click "Yes" to permanently delete the selected settings, and "No" to cancel the deletion of the selected preset.

- ◆ *Restore Defaults*: Restore the modified parameter values to the default configuration.

- ◆ *Save Configuration:* When you modified a parameter value in a setting or performed "Restore Defaults" to the modified parameter, click the "Save Configuration" button to save it, and when this configuration is selected again it will still be the saved value.
- ◆ *Import/Export:* After modifying the required parameters according to the user's requirements, save the current slicing parameters to a local file for subsequent use.

When you need to export the configuration, click the "Export" button to save the current slicing parameter settings as a local .fcfg format file.

When you need to import the configuration, click the "Import" button to import the slicing parameter configuration file in the .fcfg format into the configuration list, then there will be one more optional preset in the "Printer->Slice Configuration" list for that type of printer.

3.8.3.2 Print Gcode File by FDM 3D Printer

- 1) After the Gcode file is generated, you can send the Gcode file to the printer and start printing.
 - ◆ *Step 1:* After the model file is sliced or the saved Gcode file is loaded, the "Local Save" button will appear at the top of the main interface.
 - ◆ *Step 2:* Click the "Local Save->Send To Printer" and start printing.
- 2) Weight Estimation
 - ◆ *Material Length:* The filament length required to print the model.
 - ◆ *Material Type:* Different types of filaments can be selected for estimation, and "Material Density" can be changed manually when "Custom Material" is selected.
 - ◆ *Material Density:* The material density corresponds to the "Material Type".
 - ◆ *Weight Estimation:* The estimated material weight based on the length and density of the filament.

The preview interface of Gcode file allows you to view the slicing results of the model. By left and right sliding the "Layers" and "Steps", you can control the number of display layers of the model, observe the structure of each layer of the model, the layer height and the printing speed. The upper right corner of the preview interface displays model printing information, including "Slice File Name", "Estimated Print Time", "Estimated Print Material" and "Weight Estimation".

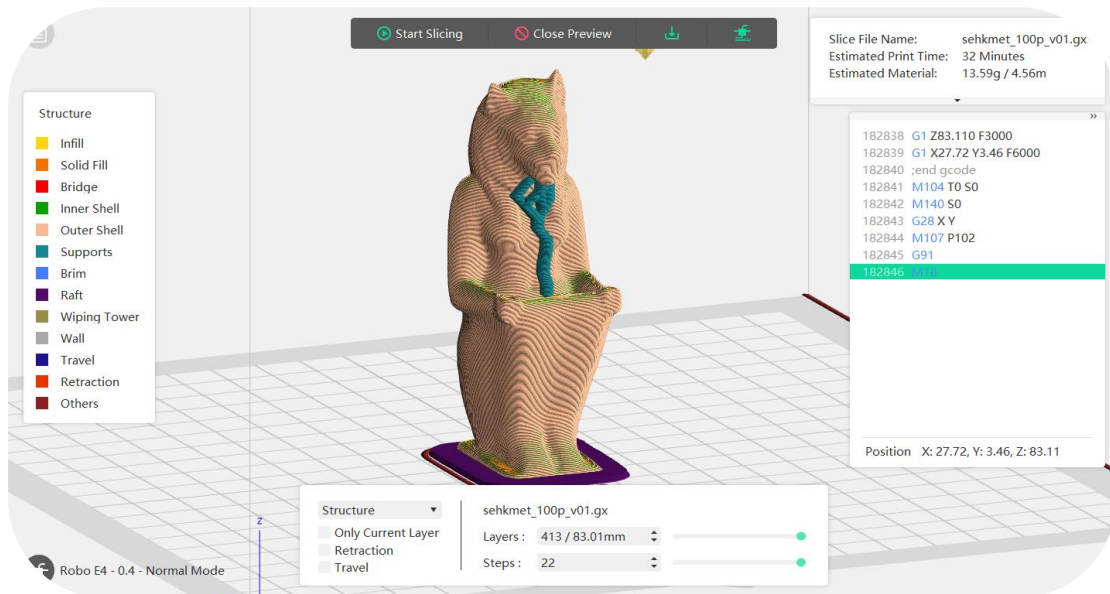

Click the "▽" button to display more slice information of the model file.

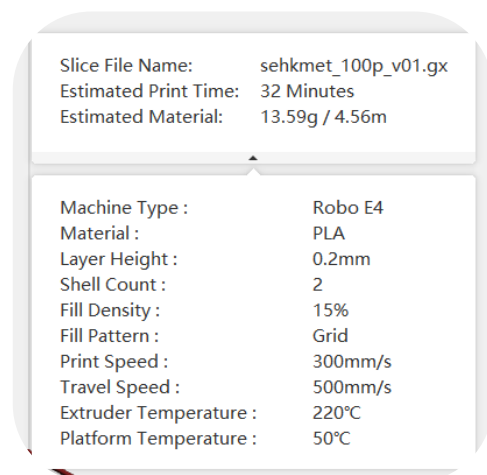

Click the "Local Save->Send To Printer" and start printing. Click the "Close Preview" button to exit the preview interface of the Gcode file.

3.8.3.3 Pause and Stop Printing

After printing is started, click the "Multi-Machine Control" button on the right side of the main interface or "Tools-> Multi-Machine Control" to enter the multi-machine control interface, which will display the current status of all connected printers, with the "Pause" and "Stop" buttons displayed at the bottom of the status bar of the current machine type.

After pausing, you can still continue printing. After stopping, the printing is canceled and cannot be restarted from where it left off.

Note: Pausing may affect the printing effect, so it is recommended not to use it when unnecessary.

3.9 Printer Operations

3.9.1 Connect/Disconnect

3.9.1.1 Connect

The computer can be connected to multiple printers at the same time. There are two connection methods: 1. Automatic connection; 2. Wi-Fi/Ethernet connection.

◆ Method 1: USB (Automatic) connection

- a. First, use the USB cable to connect the socket on the back of the printer to the computer. This USB cable option is only available on certain models. Your printer may not have it.
- b. Turn on the printer and open the RoboPrint software.
- c. Click the "Print->Connect Machine" or "Multi-Machine Control->Connect" in the menu bar, and select "Automatic Scan" as the connection method in the Connect Machine dialog box that pops up. The "Automatic Scan" connection mode will scan and display all machines that can be connected, including Wi-Fi connections and USB cable connections.
- d. Click the  button next to the printer name to connect to the printer.

Troubleshooting: If it doesn't show up, click rescan. You should also try turning your printer off and back on. If the serial port still does not appear, it means that the driver of the software is not installed (usually, the driver will be installed automatically when installing the software). If such a situation occurs, you need to install the driver manually. Please refer to Section 3.8.3.1 for the method.

◆ Method 2: Wi-Fi connection

There are two types:

- Type 1: Connect your computer to the 3D printer via wireless network.
 - a. Turn on the printer and turn on the Wi-Fi (Tools-Setting-WIFI-WIFI ON).
 - b. Turn on the wireless network selection, and select the network you would like. Enter the password and connect.

Your printer and your computer MUST be on the same network for this to work!

- c. When you scan, your printer should show up and connect automatically.

- d. If it doesn't, you can also insert the IP address of your printer into the IP Address section of "Connect Machine." The IP address location will vary from model to model of printer, but check your Info or About screen to find it on most models.

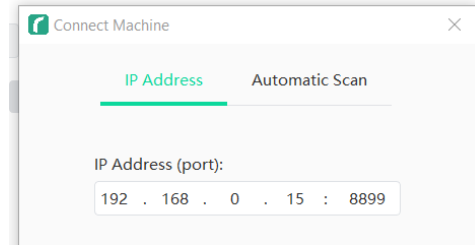

- Type 2: Set the printer as a wireless discovery source and directly connect the computer to the 3D printer.
 - a. Connect your printer to the internet using an ethernet cable and toggle ethernet on.
 - b. Turn on the printer and turn on the Hotspot. On that screen, you can find the information for connecting to the hotspot.
 - c. Connect your printer to the wireless network generated by the Hotspot.
 - d. Click the "Print->Connect Machine" in the menu bar. Try automatic scan first. If that doesn't work, go to IP Address and insert select Wi-Fi as the connection method, enter 10.10.100.254:8899 and then click the "Connect Machine" button.

Note: A machine can only establish one connection. If the machine has been occupied by another software process, it is necessary to wait for the connection to be disconnected before establishing the connection again; If you use AP mode to connect the machine, the computer will not be able to access the Internet through the wireless network.

3.9.1.2 Disconnect

When one or more printers are connected, check any printer in the Multi-Machine Control interface and click the "Disconnect" button to disconnect the computer from this printer.

Click the "Print->Disconnect All Connection" in the menu bar to disconnect the computer from all printers.

3.9.1.3 Set As Current

When the computer is connected to multiple printers at the same time, right-click on any printer after checking it in the Multi-Machine Control interface and select "Set As Current" in the pop-up menu to switch the operation interface to the interface corresponding to the currently selected printer.

3.9.1.4 Modify Printer Name

Right-click on any printer after checking it in the Multi-Machine Control interface and select "Rename" in the pop-up menu and a dialog box to modify the printer name pops up. Click "OK" after modifying the name, and the printer name is modified successfully; Click the "Cancel" button and the printer name will not be modified.

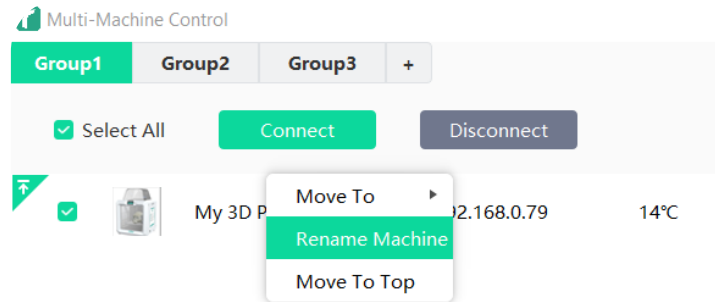

3.9.2 Control Panel

When the computer is connected to the printer, click the "Tools->Control Panel" in the menu bar to open the control panel of the printer and perform the following operations in the panel. When selecting different machine types, the display settings on the control panel are different. You may not see all of the below settings depending on your machine.

◆ Jog Controls

- a. *Jog Mode*: Select the moving distance of the extruder or build plate (that is, the moving distance of the extruder or build plate in a single direction).
- b. *Six blue direction buttons on the left*: These buttons correspond to the movements on the X, Y and Z axes respectively. The X and Y axes are used to control the horizontal position of the extruder, and the Z axis is used to control the up and down position of the build plate.

Press the X- button, and the extruder will move to the left for a specified distance; Press the X+ button, and the extruder will move to the right for a specified distance; Press Y- button, and the extruder will move to the front of the printer for a specified distance; Press the Y+ button, and the extruder will move to the back of the printer for a specified distance; Press the Z- button, and the build plate will move upward for a specified distance; Press the Z+ button, and the build plate will move downward for a specified distance (the specified distance is the moving distance set in the "Jog Mode").



- c. *Stop*: Click this button to abort the current movement operation.
- d. *XYZ coordinate frame on the right*: It displays the current positions of the extruder and build plate.
- e. *Make current position zero*: Click this button to set the current position of the extruder and build plate as the home position in any state.
- f. *Center X/Y/Z*: Click each button to make the extruder and build plate return to the original position set last time in the corresponding direction.
- g. *X/Y Speed and Z Speed*: It is used to set the moving speed of the extruder and the build plate.

◆ Limit Switch

For printer protection, there are three limit switches in the printer to control the limiting position of movement. These three switches are the maximum limit switches in X/Y/Z direction, and there are the following two switch states for them:

- a. *Not Triggered Status*: When the extruder or build plate does not move to the limiting position of the printer, the motion limit switch of the X/Y/Z axis of the printer is not triggered, and the switch state is "Not Triggered".
- b. *Triggered Status*: When the extruder or build plate has moved to the limiting position of the printer, the maximum or minimum switch of X/Y/Z axis of the printer will be triggered, and the switch state will change to "Triggered" state according to different machine type settings.

◆ **Cooling Fan Controls**

It is used to set whether the fan on the extruder side is running or not. Click the "Turn on" button to set the fan to run; Click the "Turn off" button to set the fan not to run.

◆ **Filament Detect(ion)**

It is used to check whether the filament is loaded.

◆ **Servo Controls**

It is used to control the on or off state of the servo.

◆ **Stepper Motor Controls**

It is used to set whether to turn on the stepper motor. Click the "Enable" button, the motor enters the locking state and the position of the extruder or build plate cannot be changed manually; Click the "Disable" button to allow manual changes to the position of the extruder and build plate.

◆ **LED Color**

The luminous color of the printer's built-in light bar can be changed with the "LED Color" button.

◆ **Extruder Controls**

The Extruder Controls interface is generally used for filament feeding and withdrawing operations. By setting the value of the "Motor Speed", it can be used to control the rotation speed of the filament feeding roll; By setting the value of the "Extrude Duration", it can be used to control the rotation time of the motor. Generally, it is recommended that the user select an option with a duration of 60 seconds.

Before the motor rotates, the filament must be melted in the extruder, so please wait for the extruder temperature to reach the printing temperature corresponding to the filament before performing rotating operation. If ABS filament is used, the extruder temperature should reach 220°C. If PLA filament is used, the extruder temperature should reach 200°C.

After reaching the target extruder temperature, you can click the "Forward/Reverse" button to control the filament feeding and withdrawing. In addition, if you need to stop filament feeding and withdrawing, you can click the "Stop" button.

◆ **Temperature Controls**

Enter the desired temperature in the box on the left, click the "Apply" button, and the printer will automatically start heating the corresponding part, while the right side shows the current actual temperature of the corresponding part. After starting heating, the curve

in the temperature icon below will start to change, with different colors corresponding to different temperatures of each part.

Note: In actual operation, if both the extruder and build plate need to be heated, the printer will heat the extruder after the build plate is heated.

3.9.3 Machine Information

With the computer connected to the printer, click the "Tools->Machine Information" in the menu bar to view the information about the machine, including machine type, machine name, firmware version, etc.

3.9.4 Driver Installation

The driver installation method is as follows:

- ◆ *Step 1:* Open the root directory of the software.
(for example, C:\Program Files\Boxlight\RoboPrint)
- ◆ *Step 2:* Open the driver folder under the root directory, find the driver software, and click to install (there are two installation packages: dpinst_amd64.exe corresponding to 64-bit system, dpinst_x86.exe corresponding to 32-bit system, please choose according to your needs).

3.9.5 Multi-Machine Control

Click the "Tools->Multi-Machine Control" in the menu bar, entering the multi-machine control interface.

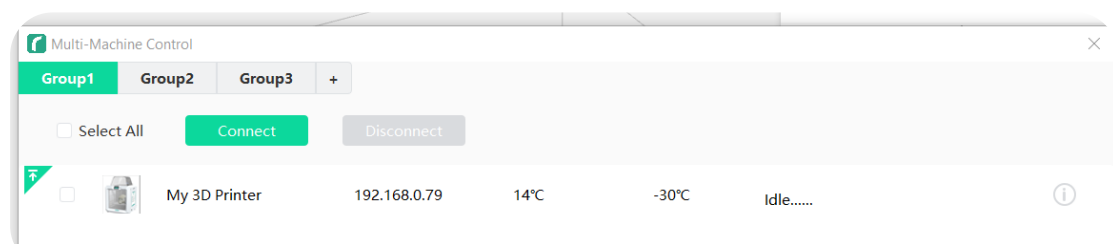

- ◆ *Connect:* The same function as "Print->Connect Machine". The connected machine will be displayed in the group.
- ◆ *Send GCode:* Send the Gcode file to the machine with the same type as the current machine type, and no Gcode files should be sent to the machine with different type from the current machine type.

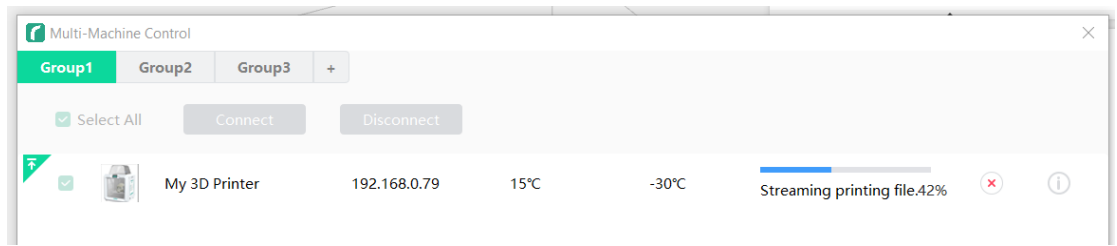

- ◆ *Continue*: Send a "continue printing" command to all printers that have been checked and are in the pause-printing status.
- ◆ *Pause*: Send a "pause printing" command to all printers that have been checked and are in the printing status.
- ◆ *Abort*: Send an "abort printing" command to all printers that have been checked and are in the printing status.
- ◆ *Disconnect*: Disconnect all printers that have been checked.
- ◆ *Move To*: Select "Move To" in the pop-up menu to move all checked printers to the designated group or to a new group.
- ◆ *Select All*: Check and select all printers in the current group.

When the printer enters the printing state, the current extruder temperature, platform temperature, target temperature and printing progress of the printer will be displayed in the basic information; The extruder temperature, platform temperature and printing speed can be set in the settings.

3.10 Others

3.10.1 Preferences

Click the "File-> Preferences" in the menu bar to select the interface language and whether to check for updates after start-up.

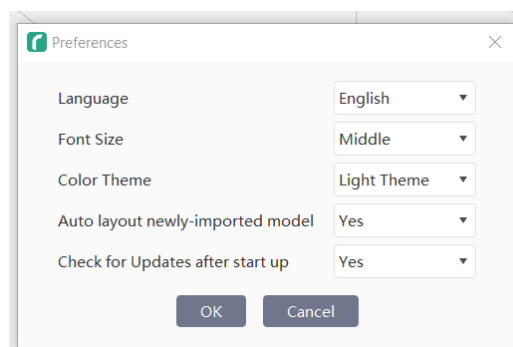

◆ Language

The interface language of the software currently supports the following fourteen languages: English, Japanese, Simplified Chinese, Traditional Chinese, French, German, Arabic, Spanish, Czech, Turkish, Portuguese, Korean, Polish and Russian. Select the desired language according to the user's needs.

After selecting the language, click the "OK" button.

◆ Font Size

The font size is relative to the monitor size. Users are free to change the font size according to custom preference.

◆ Color Theme

The user can switch the light/dark mode of the display freely.

◆ Auto layout newly-imported model

It is used to set the placement position of the model when loading the model. If "Yes" is selected in the "Auto layout newly-imported model", the first model loaded will be automatically centered and placed on the platform when loaded. If multiple items are imported, they will auto-layout to not overlap with each other.

If "No" is selected, the model will be placed according to its original location when loaded.

◆ Check for Updates after start-up

It is used to set whether to start the online automatic update function. If "Yes" is selected in the "Check for Updates after start-up", a new version of the software can be automatically detected online every time the software is started. Once a new version is found, the user will be prompted to download and install the updated version.

3.10.2 Help Contents

Click the "Help->Help Contents" in the menu bar to view the help manual online.

3.10.3 Feedback

Click the "Help->Feedback" in the menu bar, where users can give feedback and raise questions or problems.

3.10.4 Check for Updates

There are two ways to update the software version:

◆ Automatic Update

Turn on the "Check for Updates after start-up" option and the software version will be automatically updated online. Click the "Skip this version" button to skip the update. Please refer to Section 3.9.1 for details.

◆ Manual Update

Click the "Help->Check for Updates" in the menu bar to check if there is an updated software version available online. If an updated software version is detected, a new version update log will pop up, and users can choose to download and install the updated version or close the prompt according to their needs.

Note: Please refer to Section 2.1 to 2.2 for the download and installation process of the software.

3.10.5 About RoboPrint

Click the "Tools->About RoboPrint" in the menu bar, it will display the information of the software, including the current software version, copyright, and update logs (change logs).

3.10.6 Model database

Users can now import frequently-used files into the model database by themselves. After imported, those files can be easily called when relaunching the slicing software. Click to add to the base plate, the model will be imported into the platform, then you may proceed to slicing.